



Antenne 5G, 4G-LTE, 3G/2G, omnidirectionnelle, traversante | 7.3dBi

Référence EP0659M07

Gain	7.3dBi
Connecteurs	N femelle
Dimensions (mm)	Ø 190 × 33

L'EP0659M07 est une antenne plafond conçue pour les applications cellulaires multi-bandes 5G, 4G-LTE, 3G et 2G.

Elle couvre une très large plage de fréquences allant de 600 MHz jusqu'à 5925 GHz, incluant notamment les bandes 600 à 900 MHz, 1500 MHz, 1700 à 2100 MHz, 2300 à 2690 MHz et 3300 à 5000 MHz ainsi que les bandes 5 GHz utilisées pour certaines applications sans fil.

Sur le plan des performances radio, elle présente un rapport d'ondes stationnaires (VSWR) maîtrisé, inférieur ou égal à 2,0 sur la majorité des bandes et à 2,5 sur les bandes basses, garantissant une bonne adaptation d'impédance et une transmission efficace du signal.

L'efficacité de rayonnement est particulièrement élevée, atteignant jusqu'à près de 100 % selon la bande de fréquence, avec des gains moyens compris entre -0,5 dBi et 0,3 dBi et des gains maximal pouvant atteindre jusqu'à 7,3 dBi.

L'impédance de 50 ohms, avec une polarisation verticale et un diagramme de rayonnement omnidirectionnel, assure une couverture homogène dans toutes les directions horizontales.

INSTALLATION

Conçue pour un montage au plafond, elle se fixe rapidement grâce à un système de clips à ressort.

Elle adopte un design compact et discret, avec un diamètre de 190 mm, une hauteur de 33 mm et un poids d'environ 195 g.

Son radôme en ABS blanc assure robustesse et intégration esthétique dans les environnements intérieurs professionnels.

ENVIRONNEMENT

Sur le plan environnemental, l'antenne est conforme à la directive RoHS, attestant de l'absence de substances dangereuses et de sa conformité aux exigences réglementaires européennes.



CARACTÉRISTIQUES

BANDES	600/700/850/900	1500	1700/1800/1900/2100	2600	3500/3700/4700	5200/5900
FRÉQUENCE(S) (MHZ)	619-960	1427-1518	1710-2170	2300-2690	3300-5000	5150-5925
VSWR	≤2,5	≤2.0	≤2.0	≤2.0	≤2.0	≤2.0
EFFICACITÉ (%) ¹	93,7	89,7	96.0	99,3	99,4	99,8
GAIN MOYEN (DBI)	-0,3	-0,5	-0,2	0,1	0,1	0,3
GAIN MAXIMAL (DBI)	5.3	4.0	5.8	7.1	6.8	7.3
IMPÉDANCE (OHMS) (Ω)	50					
POLARISATION	Verticale					
DIAGRAMME DE RAYONNEMENT	Omnidirectionnel					

- L'antenne a été mesurée en espace libre en tant qu'unité autonome, sans plan de masse.
- ¹ désigne la valeur moyenne sur la plage de fréquences mesurée.
- Les spécifications et données ci-dessus sont susceptibles de varier en fonction de l'orientation de l'antenne, du plan de masse, de l'application, du câble, du connecteur, du boîtier et de l'environnement d'installation.
- Les performances réelles peuvent différer selon l'environnement d'application final du client et doivent être validées lors de l'intégration finale.

SPÉCIFICATIONS

DIMENSIONS	Ø190 × 33 mm
POIDS	195 g
RADOME	ABS blanc
TYPE DE CÂBLE	Équivalent RG-402
CONNECTEUR	Femelle de type N
TYPE DE MONTAGE	Support de plafond

ENVIRONNEMENT

CONFORMITÉ	RoHS
------------	------



MESURES

VSWR

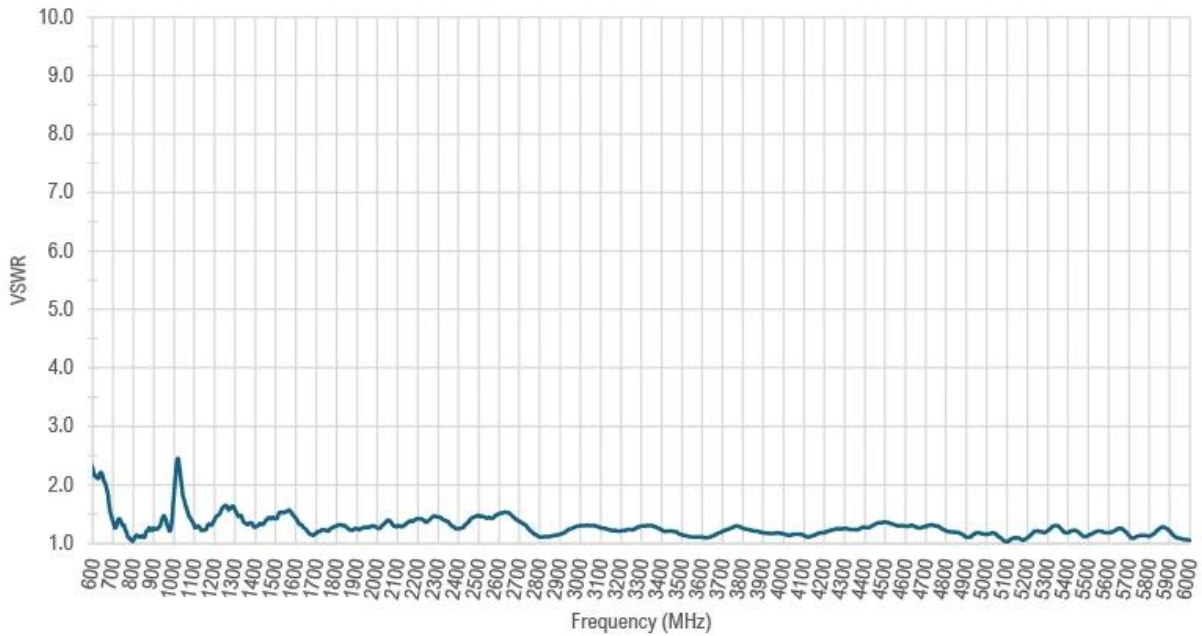

Return Loss

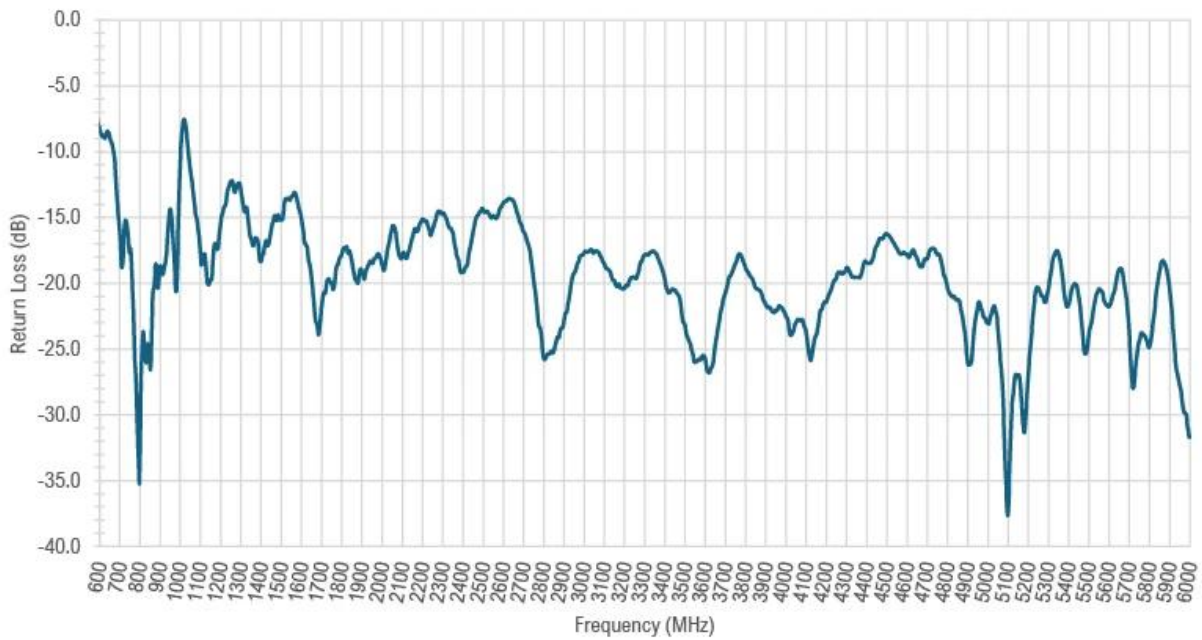



OTA Testing Setup



Efficiency & Gain

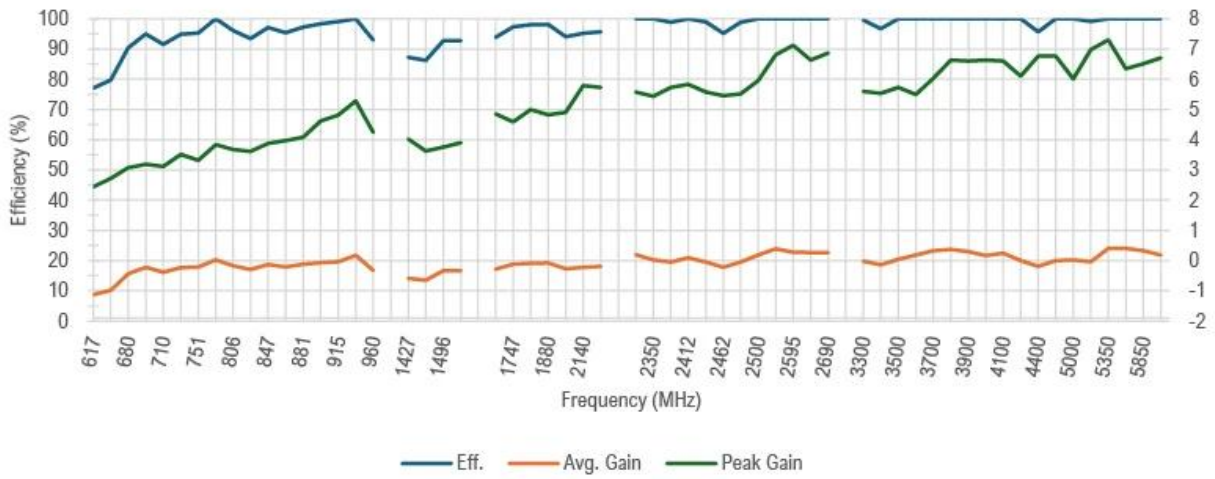



2D Radiation Patterns : H-Plane & E-Plane

(Theta=90°)

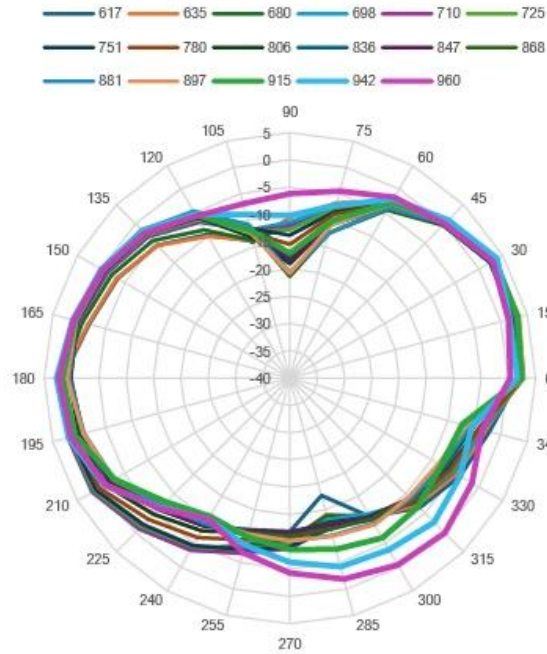

(Phi=0°)

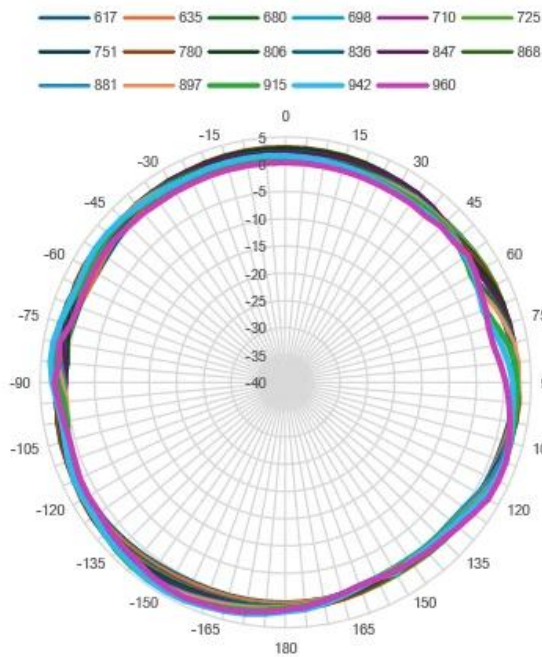

(Phi=90°)

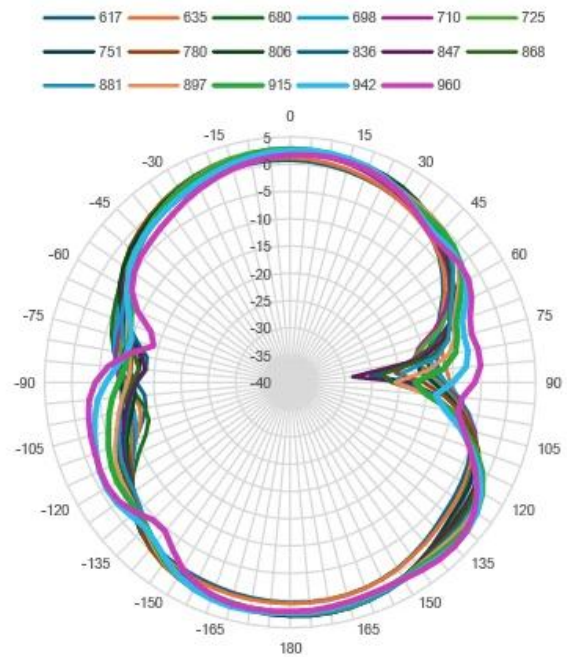



(Theta=90°)

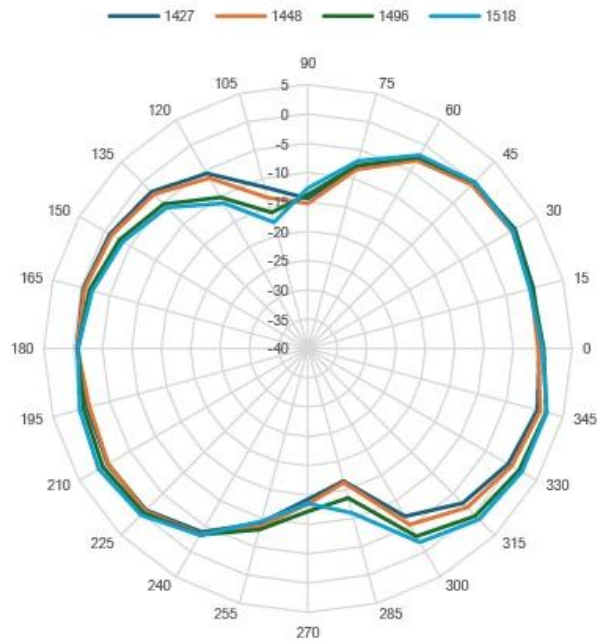

(Phi=0°)

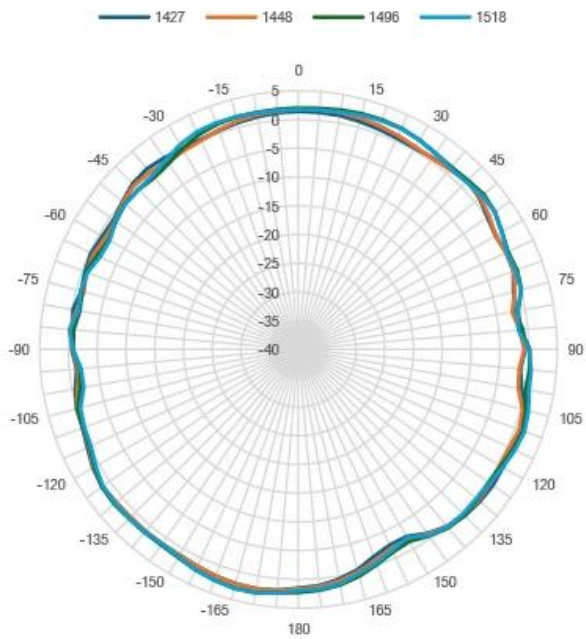

(Phi=90°)

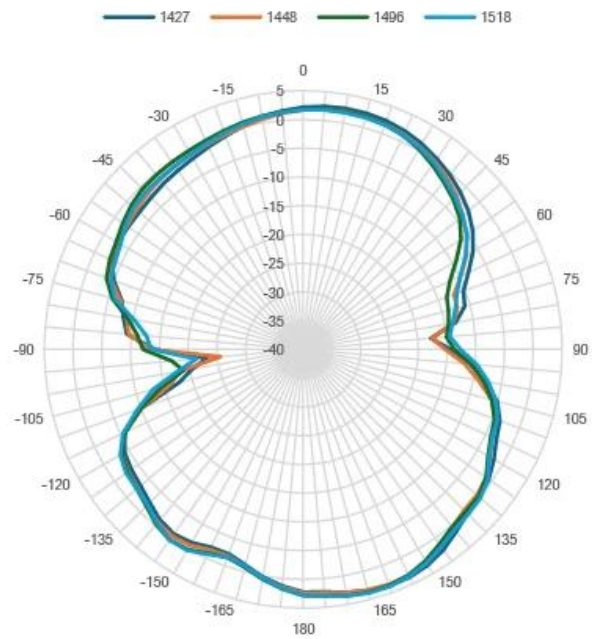



(Theta=90°)

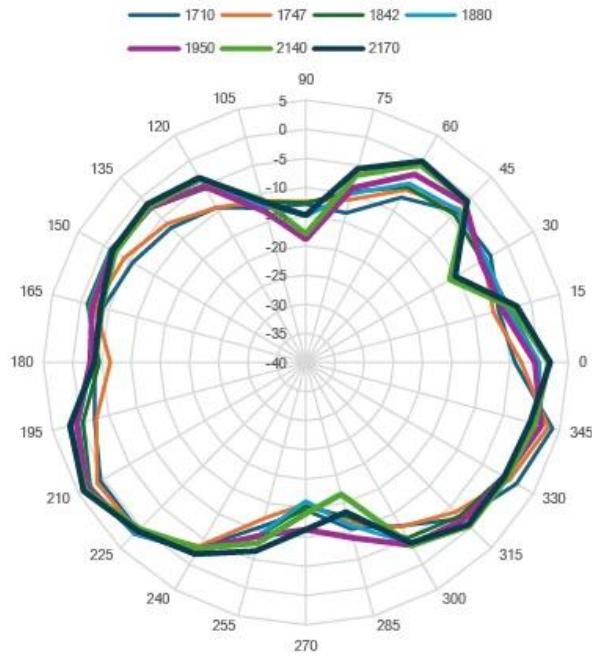

(Phi=0°)

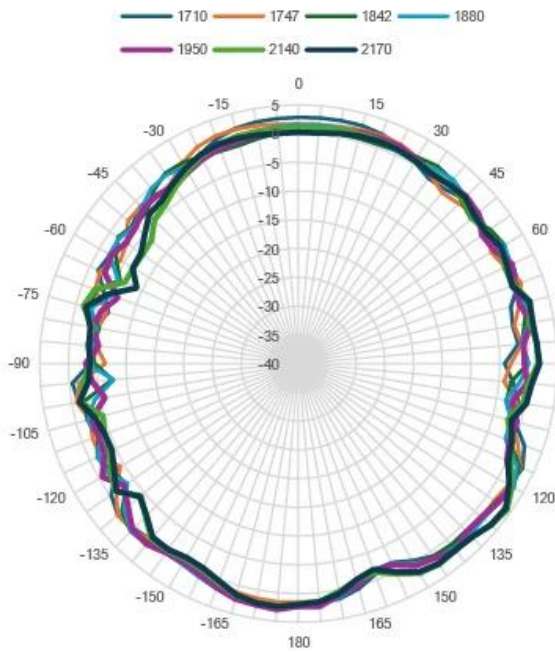

(Phi=90°)

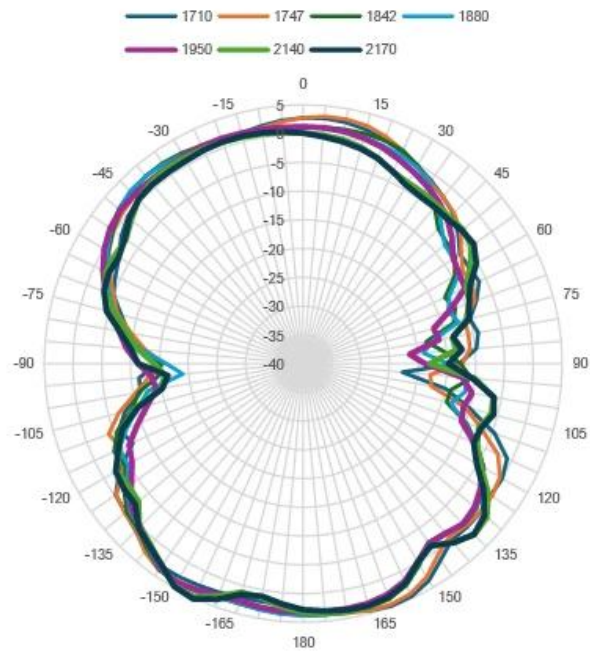



(Theta=90°)

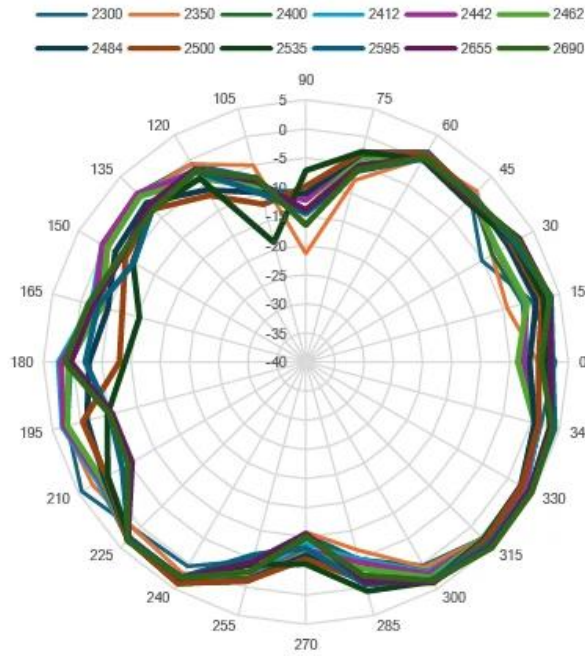

(Phi=0°)

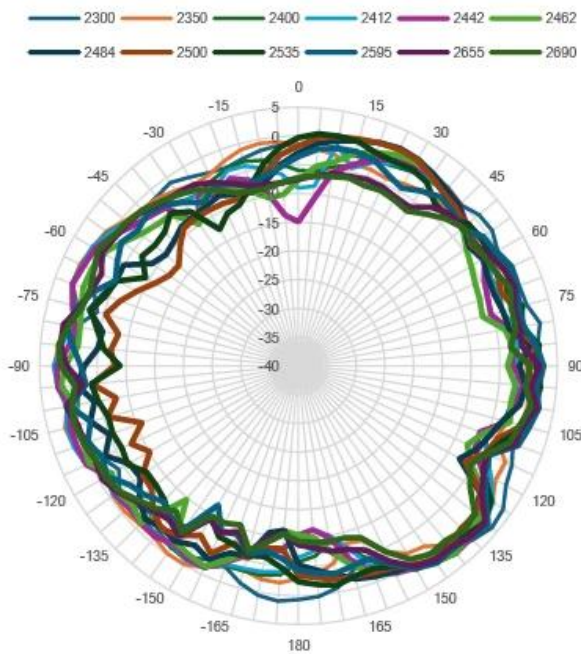

(Phi=90°)

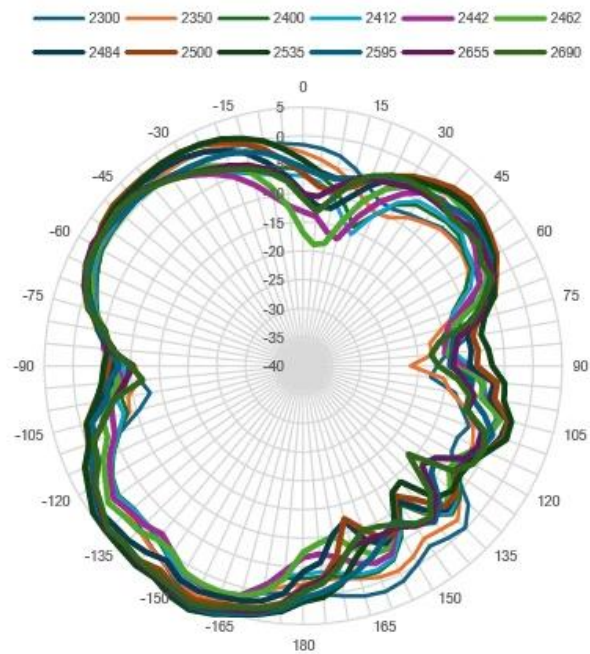



(Theta=90°)

- 3300 — 3400 — 3500 — 3600 — 3700
- 3800 — 3900 — 4000 — 4100 — 4200
- 4400 — 4700 — 5000

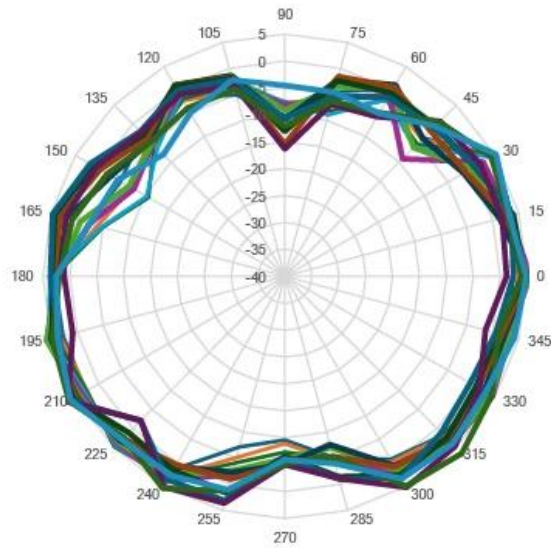

(Phi=0°)

- 3300 — 3400 — 3500 — 3600 — 3700
- 3800 — 3900 — 4000 — 4100 — 4200
- 4400 — 4700 — 5000

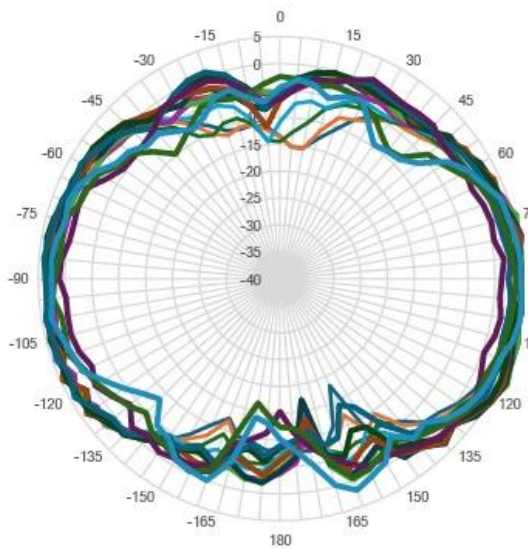

(Phi=90°)

- 3300 — 3400 — 3500 — 3600 — 3700
- 3800 — 3900 — 4000 — 4100 — 4200
- 4400 — 4700 — 5000

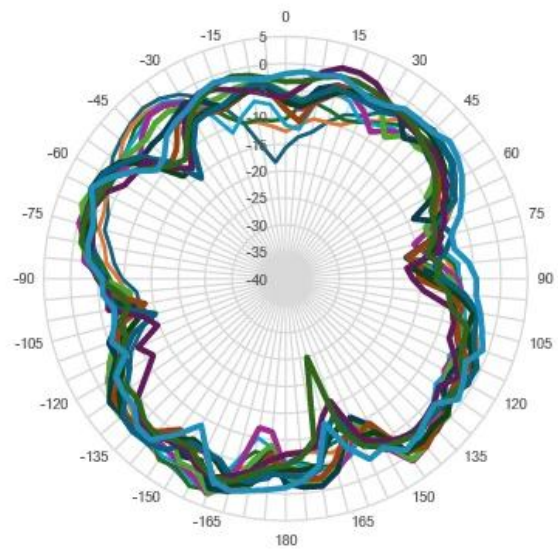



(Theta=90°)

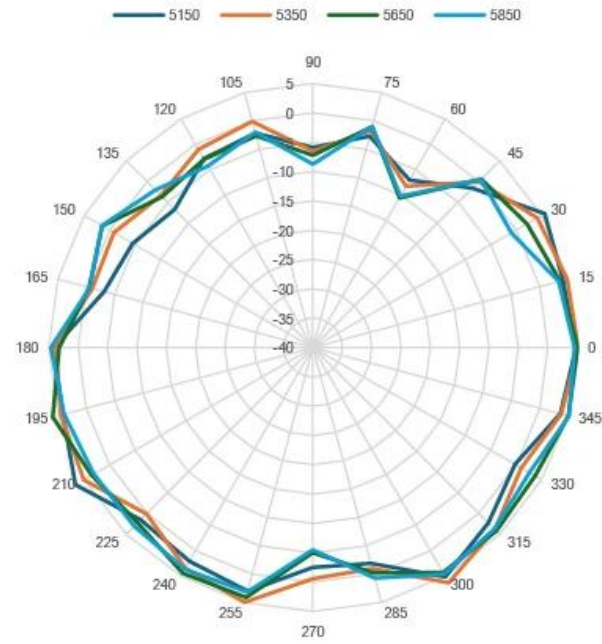

(Phi=0°)

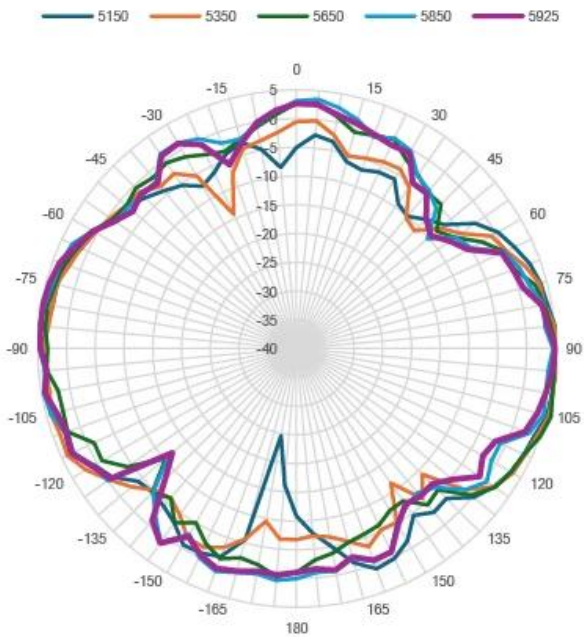

(Phi=90°)

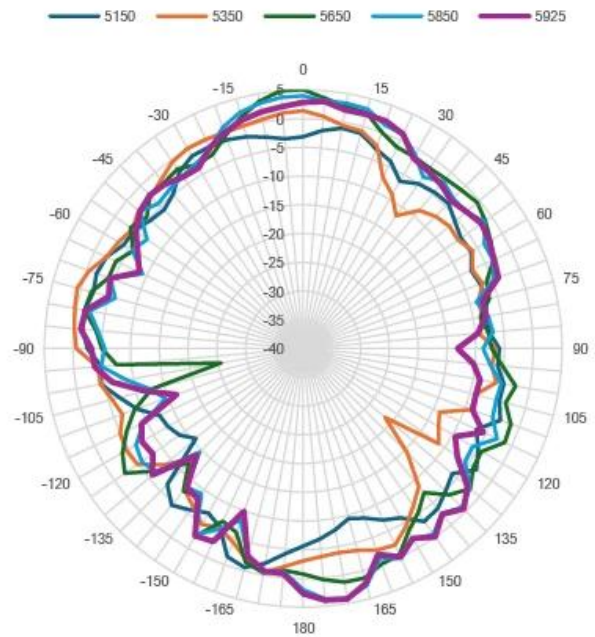



3D Radiation Patterns

0.635GHz

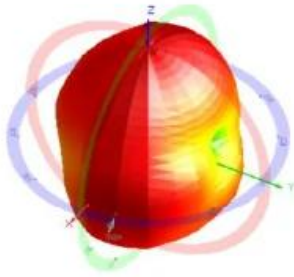

0.680GHz

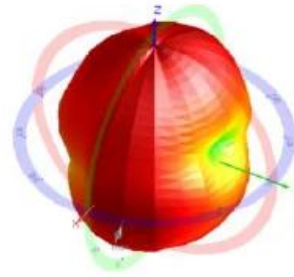

0.710GHz

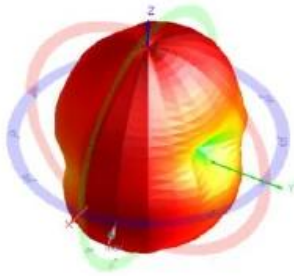

0.751GHz

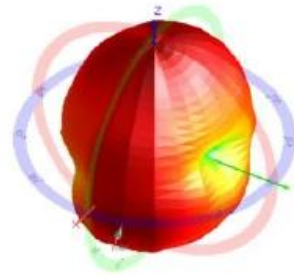

0.806GHz

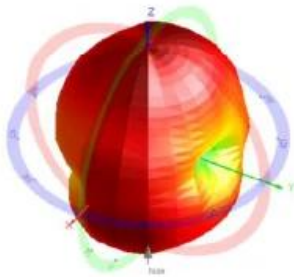

0.847GHz

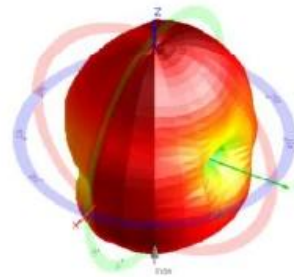

0.881GHz

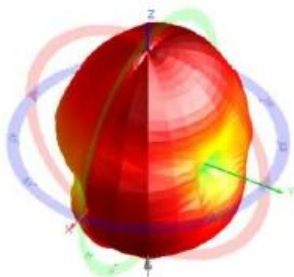

0.942GHz

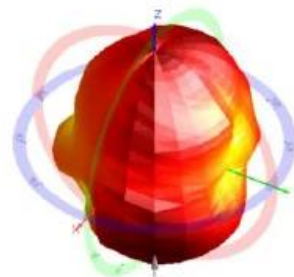



1.427GHz

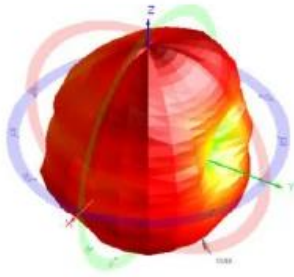

1.448GHz

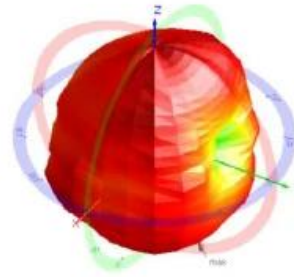

1.496GHz

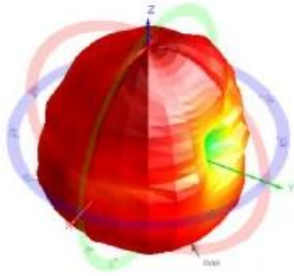

1.518GHz

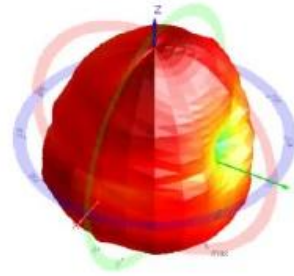

1.747GHz

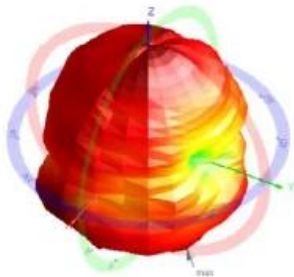

1.842GHz

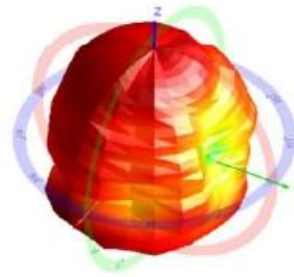

1.950GHz

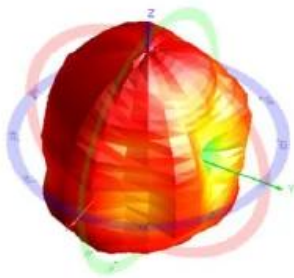

2.140GHz

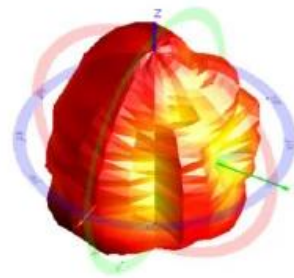



2.350GHz

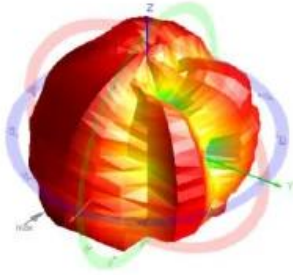

2.442GHz

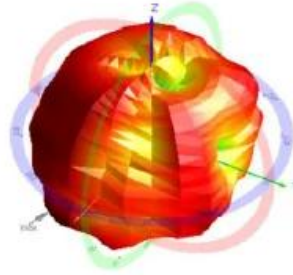

2.535GHz

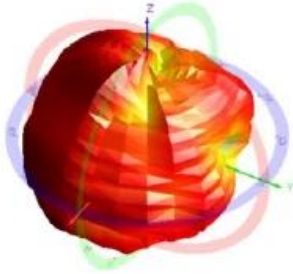

2.655GHz

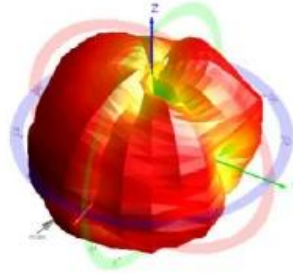

3.500GHz

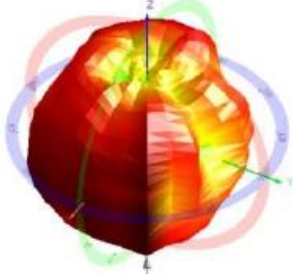

3.700GHz

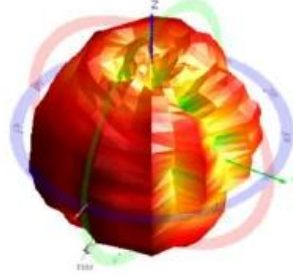

3.800GHz

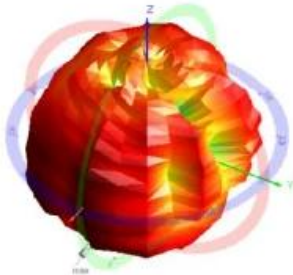

4.000GHz

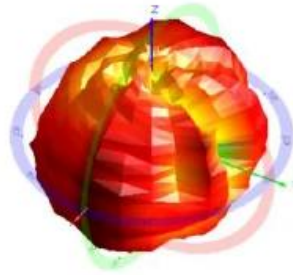



4.200GHz

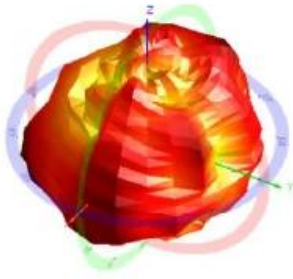

4.400GHz

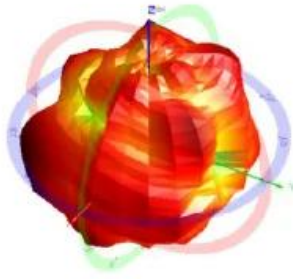

4.700GHz

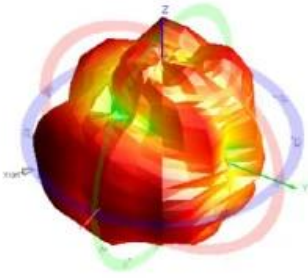

5.000GHz

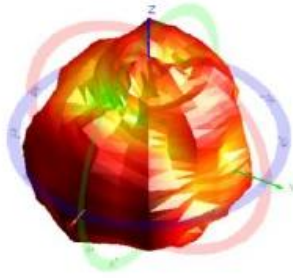

5.150GHz

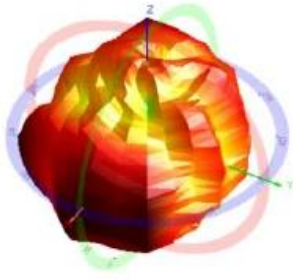

5.350GHz

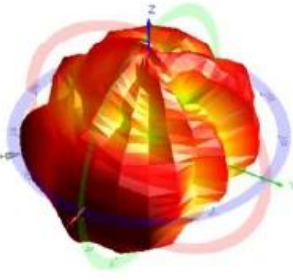

5.650GHz

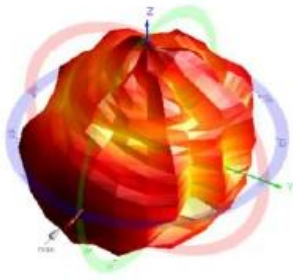

5.850GHz

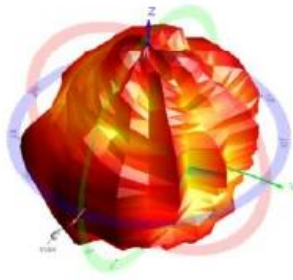



SCHÉMA(S)

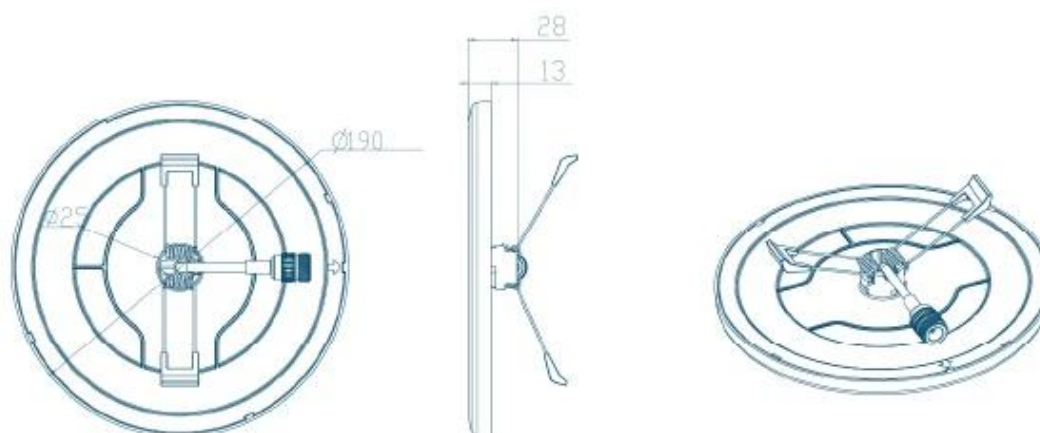

Installation guide

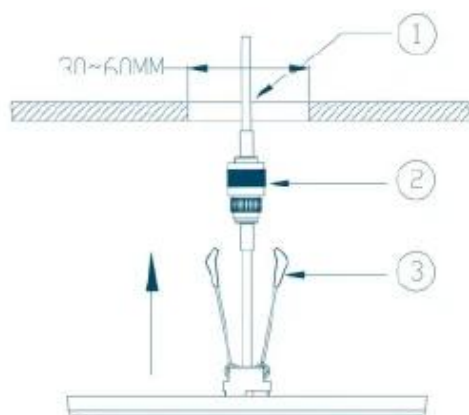

- ① **Prepare the Hole**
Cut a round hole (Diameter : Ø30 mm ~ Ø60 mm).
- ② **Connect the Antenna**
Connect the antenna connector to the mating connector.
- ③ **Compress the Spring Clips**
Press and hole the spring clips together toward the center of the antenna body.
- ④ **Insert the Antenna**
While keeping the clips compressed, push the antenna upward into the prepared hole.
- ⑤ **Secure in Place**
Release the clips once they are clear of the hole.
Allow the spring clips to expand naturally, which will pull the antenna tight against the ceiling surface.