



**Antenne combinée 4×[5G 4G-LTE 3G/2G LPWA]
4×[2.4/5GHz WiFi6E] GPS/GNSS | 6.1dBi /
28dB@2.7V**

Référence **GC-4h86mcf**

Gain	6.1dBi / 28dB@2.7V
Connecteurs	SMA (M) / SMA-RP (M)
Dimensions (mm)	198 × 127 × 51
T° de fonctionnement	-40°C à +85°C

SOLUTION 9-EN-1

L'antenne combinée GC-4H86MCFD offre des performances supérieures avec 4 antennes 5G MIMO, 4 antennes ISM MIMO 2.4/5.0/6.0 GHz, et une connectivité GPS/GNSS.

CÂBLES 1 À 4 : 5G NR

Quatre antennes conçues pour les appareils qui fonctionnent dans toutes les normes 5G, 4G-LTE, FirstNet, CBRS, LPWA, CAT-X, CAT-Mx, CAT-NBx, NB-IoT, 3G et 2G.

CÂBLES 5 À 8 : WIFI 6E ISM 2,4/5,0/6,0 GHZ

Les câbles 5 à 8 sont conçus pour les dispositifs qui fonctionnent dans les normes WiFi, Bluetooth, ZigBee et ISM/LPWA. Les bandes 2.4/5.0 GHz et 6.0 GHz combinent **courte et longue portée**, et une très grande capacité de communication, sans entrer en concurrence avec le trafic d'autres appareils ou réseaux.

CÂBLE 9 : GPS/GNSS

Antenne dédiée aux applications de **navigation de précision** qui fonctionnent selon les normes GPS et GNSS. Conçue avec un **diagramme de rayonnement hémisphérique** et une polarisation circulaire à droite, elle rayonne sur tous les plans et maximise la connectivité.

Elle peut maintenir un gain actif de 28 dB @ 2.7V et un facteur de bruit de 1,8 dans le récepteur. Le post-filtre SAW bloque les fréquences inadéquates avec une réjection hors bande de ~43 dB sur les bandes 1561-1602 MHz.

INSTALLATION / ENVIRONNEMENT

Indépendante du plan de masse, cette antenne peut être facilement installée avec le support magnétique robuste sur des surfaces métalliques telles que des véhicules et des bâtiments métalliques pour des applications permanentes ou temporaires.

Fabriquée en acrylonitrile styrène acrylate (ASA), son boîtier à profil bas ne mesure que 198 × 126 × 50,7 mm, ce qui rend cette antenne 55 % plus petite que toute autre antenne de ce type sur le marché.

Les indices d'étanchéité IP67 et IP69 offrent à cette antenne compacte une protection maximale contre la poussière et la pénétration de l'eau, tandis que l'indice IK09 ajoute un niveau supplémentaire de sécurité & une résistance élevée aux chocs.



CARACTÉRISTIQUES

Câble 1 : 2G/3G/4G/5G - IoT/LPWAN

FRÉQUENCE(S) (MHZ)	617-960	1427-2690	3300-5000	5150-5925
BANDE(S) (MHZ)	600, 700, 850, 900	1500, 1600, 1700, 1800, 1900, 2000, 2100, 2300, 2500, 2600	3300, 3500, 3600, 3700, 4500	5200, 5500, 5800
BANDES 5G NR	n5, n8, 12, n20, n28, n71, n81, n82, n83,	n1, n2, n3, n7, n25, n34, n38, n39, n40, n41, n50, n51, n66, n70, n74, n75, n76, n80, n84, n86	n77, n78, n79	
BANDES 4G-LTE	B5, B6, B8, B12, B13, B14, B17, B18, B19, B20, B26, B27, B28, B29, B44, B67, B68, B71, B85	B1, B2, B3, B4, B7, B9, B10, B11, B21, B23, B24, B25, B30, B32, B33, B34, B35, B36, B37, B38, B39, B40, B41, B45, B50, B51, B65, B66, B69, B70, B74, B75, B76	B22, B42, B43, B48, B49, B52	B46, B47, B252, B255
BANDES 3G	B5, B6, B8, B12, B13, B14, B19, B20, B26	B1, B2, B3, B4, B7, B9, B10, B11, B21, B25, B32, B33, B34, B35, B36, B37, B38, B39, B40	B22	
BANDES 2G	710, 750, 810T, 850, 900P, 900E, 900R	1800DCS, 1900PCS		
BANDES CDMA	BC0, BC2, BC3, BC7, BC9, BC10, BC12, BC18, BC19	BC1, BC4, BC6, BC8, BC13, BC14, BC15, BC16, BC20, BC21		
PERTE DE RETOUR (DB)	~-16.3	~-14.9	~-13.1	~-12.9
VSWR	~1.5:1	~1.5:1	~1.7:1	~1.7:1
EFFICACITÉ (%)	~58,0	~49,4	~32,3	~32,1
GAIN MAXIMAL (DBI)	~3.2	~5.2	~4,5	~4,5
GAIN MOYEN (DB)	~-2.4	~-3.1	~-4.9	~-5.0
IMPÉDANCE (OHMS)	50			
POLARISATION	Linéaire			
RAYONNEMENT	Omnidirectionnel			
PUISSANCE D'ENTRÉE MAX. (W)	25			



Câble 2 : 2G/3G/4G/5G - IoT/LPWAN

FRÉQUENCE(S) (MHZ)	617-960	1427-2690	3300-5000	5150-5925
BANDE(S) (MHZ)	600, 700, 850, 900	1500, 1600, 1700, 1800, 1900, 2000, 2100, 2300, 2500, 2600	3300, 3500, 3600, 3700, 4500	5200, 5500, 5800
BANDES 5G NR	n5, n8, 12, n20, n28, n71, n81, n82, n83,	n1, n2, n3, n7, n25, n34, n38, n39, n40, n41, n50, n51, n66, n70, n74, n75, n76, n80, n84, n86	n77, n78, n79	
BANDES 4G-LTE	B5, B6, B8, B12, B13, B14, B17, B18, B19, B20, B26, B27, B28, B29, B44, B67, B68, B71, B85	B1, B2, B3, B4, B7, B9, B10, B11, B21, B23, B24, B25, B30, B32, B33, B34, B35, B36, B37, B38, B39, B40, B41, B45, B50, B51, B65, B66, B69, B70, B74, B75, B76	B22, B42, B43, B48, B49, B52	B46, B47, B252, B255
BANDES 3G	B5, B6, B8, B12, B13, B14, B19, B20, B26	B1, B2, B3, B4, B7, B9, B10, B11, B21, B25, B32, B33, B34, B35, B36, B37, B38, B39, B40	B22	
BANDES 2G	710, 750, 810T, 850, 900P, 900E, 900R	1800DCS, 1900PCS		
BANDES CDMA	BC0, BC2, BC3, BC7, BC9, BC10, BC12, BC18, BC19	BC1, BC4, BC6, BC8, BC13, BC14, BC15, BC16, BC20, BC21		
PERTE DE RETOUR (DB)	~-14.9	~-14.6	~-15.3	~-15.2
VSWR	~1.6:1	~1.5:1	~1.6:1	~1.4:1
EFFICACITÉ (%)	~58,1	~47,0	~35,5	~39,8
GAIN MAXIMAL (DBI)	~3,9	~5.8	~5.6	~6,6
GAIN MOYEN (DB)	~-2.4	~-3.3	~-4.6	~-4.0
IMPÉDANCE (OHMS)	50			
POLARISATION	Linéaire			
RAYONNEMENT	Omnidirectionnel			
PUISSANCE D'ENTRÉE MAX. (W)	25			



Câble 3 : 2G/3G/4G/5G - IoT/LPWAN

FRÉQUENCE(S) (MHZ)	617-960	1427-2690	3300-5000	5150-5925
BANDE(S) (MHZ)	600, 700, 850, 900	1500, 1600, 1700, 1800, 1900, 2000, 2100, 2300, 2500, 2600	3300, 3500, 3600, 3700, 4500	5200, 5500, 5800
BANDES 5G NR	n5, n8, 12, n20, n28, n71, n81, n82, n83,	n1, n2, n3, n7, n25, n34, n38, n39, n40, n41, n50, n51, n66, n70, n74, n75, n76, n80, n84, n86	n77, n78, n79	
BANDES 4G-LTE	B5, B6, B8, B12, B13, B14, B17, B18, B19, B20, B26, B27, B28, B29, B44, B67, B68, B71, B85	B1, B2, B3, B4, B7, B9, B10, B11, B21, B23, B24, B25, B30, B32, B33, B34, B35, B36, B37, B38, B39, B40, B41, B45, B50, B51, B65, B66, B69, B70, B74, B75, B76	B22, B42, B43, B48, B49, B52	B46, B47, B252, B255
BANDES 3G	B5, B6, B8, B12, B13, B14, B19, B20, B26	B1, B2, B3, B4, B7, B9, B10, B11, B21, B25, B32, B33, B34, B35, B36, B37, B38, B39, B40	B22	
BANDES 2G	710, 750, 810T, 850, 900P, 900E, 900R	1800DCS, 1900PCS		
BANDES CDMA	BC0, BC2, BC3, BC7, BC9, BC10, BC12, BC18, BC19	BC1, BC4, BC6, BC8, BC13, BC14, BC15, BC16, BC20, BC21		
PERTE DE RETOUR (DB)	~-16.2	~-14.2	~-14.4	~-13.2
VSWR	~1.6:1	~1.6:1	~1.6:1	~1.6:1
EFFICACITÉ (%)	~58,0	~46,7	~35,8	~36,7
GAIN MAXIMAL (DBI)	~3,4	~5.8	~5.3	~5.7
GAIN MOYEN (DB)	~-2.4	~-3.3	~-4.5	~-4.4
IMPÉDANCE (OHMS)	50			
POLARISATION	Linéaire			
RAYONNEMENT	Omnidirectionnel			
PUISSANCE D'ENTRÉE MAX. (W)	25			



Câble 4 : 2G/3G/4G/5G - IoT/LPWAN

FRÉQUENCE(S) (MHZ)	617-960	1427-2690	3300-5000	5150-5925
BANDE(S) (MHZ)	600, 700, 850, 900	1500, 1600, 1700, 1800, 1900, 2000, 2100, 2300, 2500, 2600	3300, 3500, 3600, 3700, 4500	5200, 5500, 5800
BANDES 5G NR	n5, n8, 12, n20, n28, n71, n81, n82, n83,	n1, n2, n3, n7, n25, n34, n38, n39, n40, n41, n50, n51, n66, n70, n74, n75, n76, n80, n84, n86	n77, n78, n79	
BANDES 4G-LTE	B5, B6, B8, B12, B13, B14, B17, B18, B19, B20, B26, B27, B28, B29, B44, B67, B68, B71, B85	B1, B2, B3, B4, B7, B9, B10, B11, B21, B23, B24, B25, B30, B32, B33, B34, B35, B36, B37, B38, B39, B40, B41, B45, B50, B51, B65, B66, B69, B70, B74, B75, B76	B22, B42, B43, B48, B49, B52	B46, B47, B252, B255
BANDES 3G	B5, B6, B8, B12, B13, B14, B19, B20, B26	B1, B2, B3, B4, B7, B9, B10, B11, B21, B25, B32, B33, B34, B35, B36, B37, B38, B39, B40	B22	
BANDES 2G	710, 750, 810T, 850, 900P, 900E, 900R	1800DCS, 1900PCS		
BANDES CDMA	BC0, BC2, BC3, BC7, BC9, BC10, BC12, BC18, BC19	BC1, BC4, BC6, BC8, BC13, BC14, BC15, BC16, BC20, BC21		
PERTE DE RETOUR (DB)	~-16.2	~-15,5	~-13.1	~-13.1
VSWR	~1.4:1	~1.5:1	~1.7:1	~1.6:1
EFFICACITÉ (%)	~58,2	~47,3	~33,9	~37,6
GAIN MAXIMAL (DBI)	~3,5	~5.7	~5.1	~5.8
GAIN MOYEN (DB)	~-2.4	~-3.3	~-4.7	~-4.3
IMPÉDANCE (OHMS)	50			
POLARISATION	Linéaire			
RAYONNEMENT	Omnidirectionnel			
PUISSANCE D'ENTRÉE MAX. (W)	25			



Caractéristiques communes Câbles 1, 2, 3 et 4

CONNECTEUR	Norme(s) SMA-Mâle (autres connecteurs disponibles)
LONGUEUR DE CÂBLE	300 cm standard (toute longueur de câble disponible)
TYPE DE CÂBLE	Norme(s) D302 (autres câbles disponibles)

Câble 5 : ISM 2,4 / 5.0 / 6.0 GHz – WiFi, Bluetooth, ZigBee

BANDE(S) (MHZ)	2,4 GHz	5,0 GHz	6,0 GHz
FRÉQUENCE(S) (MHZ)	2410-2490	4920-5925	5925-7125
PERTE DE RETOUR (DB)	~-13.4	~-16.0	~-13.4
VSWR	~1.6:1	~1.5:1	~1.6:1
EFFICACITÉ (%)	~31.1	~22,8	~31.1
GAIN MAXIMAL (DBI)	~4.6	~3.3	~4.6
GAIN MOYEN (DB)	~-5.1	~-6.5	~-5.1
IMPÉDANCE (OHMS)	50		
POLARISATION	Linéaire		
RAYONNEMENT	Omnidirectionnel		
PUISSANCE D'ENTRÉE MAX. (W)	25		

Câble 6 : ISM 2,4 / 5.0 / 6.0 GHz – WiFi, Bluetooth, ZigBee

BANDE(S) (MHZ)	2,4 GHz	5,0 GHz	6,0 GHz
FRÉQUENCE(S) (MHZ)	2410-2490	4920-5925	5925-7125
PERTE DE RETOUR (DB)	~-12.9	~-13.2	~-11.9
VSWR	~1.7:1	~1.7:1	~1.8:1
EFFICACITÉ (%)	~37,7	~31,2	~42,6
GAIN MAXIMAL (DBI)	~6.1	~4,5	~3.2
GAIN MOYEN (DB)	~-4.2	~-5.1	~-3.5
IMPÉDANCE (OHMS)	50		
POLARISATION	Linéaire		
RAYONNEMENT	Omnidirectionnel		
PUISSANCE D'ENTRÉE MAX. (W)	25		



Câble 7 : ISM 2,4 / 5.0 / 6.0 GHz – WiFi, Bluetooth, ZigBee

BANDE(S) (MHZ)	2,4 GHz	5,0 GHz	6,0 GHz
FRÉQUENCE(S) (MHZ)	2410-2490	4920-5925	5925-7125
PERTE DE RETOUR (DB)	~-19.2	~-14.8	~-13.3
VSWR	~1.3:1	~1.6:1	~1.2:1
EFFICACITÉ (%)	~37,9	~34,5	~44,7
GAIN MAXIMAL (DBI)	~2,7	~2,3	~3.2
GAIN MOYEN (DB)	~-4.2	~-4.6	~-3.4
IMPÉDANCE (OHMS)	50		
POLARISATION	Linéaire		
RAYONNEMENT	Omnidirectionnel		
PUISSANCE D'ENTRÉE MAX. (W)	25		

Câble 8 : ISM 2,4 / 5.0 / 6.0 GHz – WiFi, Bluetooth, ZigBee

BANDE(S) (MHZ)	2,4 GHz	5,0 GHz	6,0 GHz
FRÉQUENCE(S) (MHZ)	2410-2490	4920-5925	5925-7125
PERTE DE RETOUR (DB)	~-16,5	~-16.8	~-7.5
VSWR	~1.4:1	~1.4:1	~1.6:1
EFFICACITÉ (%)	~36,7	~30,8	~39,7
GAIN MAXIMAL (DBI)	~4.4	~2,6	~3.0
GAIN MOYEN (DB)	~-4.4	~-5.1	~-4.1
IMPÉDANCE (OHMS)	50		
POLARISATION	Linéaire		
RAYONNEMENT	Omnidirectionnel		
PUISSANCE D'ENTRÉE MAX. (W)	25		



Conditions de mesure de l'antenne :

- Montée sur plaque métallique de 30 × 30 cm
- 100 cm de Câble D302
- Mesurée dans une chambre anéchoïque certifiée CTIA 3D

Caractéristiques communes **Câbles 5, 6, 7 et 8**

CONNECTEUR	Norme(s) SMA-Mâle-RP (autres connecteurs disponibles)
LONGUEUR DE CÂBLE	300 cm standard (toute longueur de câble disponible)
TYPE DE CÂBLE	Norme(s) D302 (autres câbles disponibles)

Câble 9 : GPS/QZSS/Galileo/GLONASS

NORMES	Beidou	GPS/QZSS/Galileo	GLONASS
BANDES (MHZ)	1561	1575	1602
FRÉQUENCE(S) (MHZ)	1561.098	1575.42	1598-1606
GAIN PASSIF (DBI)	~4.2	~4,5	~5.0
IMPÉDANCE (OHMS)	50		
RAYONNEMENT	Hémisphérique		
PLAGE DE TENSION (V)	1,5 - 3,6		
GAIN ACTIF (DB)	28 à 2,7 V		
FACTEUR DE BRUIT (DB)	1,8 à 2,7 V		
CONSOMMATION DE COURANT (MA)	9 à 2,7 V		
CONSOMMATION ÉLECTRIQUE (MW)	24,3 à 2,7 V		
FILTRE SAW	Pré-filtre		
RÉJECTION HORS BANDE (DB)	~43		
PROTECTION ESD (KV)	6		
CONNECTEUR	Norme SMA-Mâle (autres connecteurs disponibles)		
LONGUEUR DE CÂBLE	300 cm standard (toute longueur de câble disponible)		
TYPE DE CÂBLE	Norme LL100 (autres câbles disponibles)		



SPÉCIFICATIONS

TYPE DE MONTAGE	Support magnétique
DIMENSIONS (MM)	198 × 127 × 51
MATÉRIAU RADÔME	ASA
COULEUR RADÔME	Noir
T° DE FONCTIONNEMENT (°C)	-40 à +85
T° DE STOCKAGE (°C)	-40 à +85
CERTIFICATION(S)	RoHS
INDICE(S) DE PROTECTION	IP67, IP69, CE

ENVIRONNEMENT

Cette gamme d'antenne est fabriquée sans matières dangereuses tout en maintenant une conformité totale avec REACH et RoHS.





MESURES

Câble 1 : 2G/3G/4G/5G - IoT/LPWAN

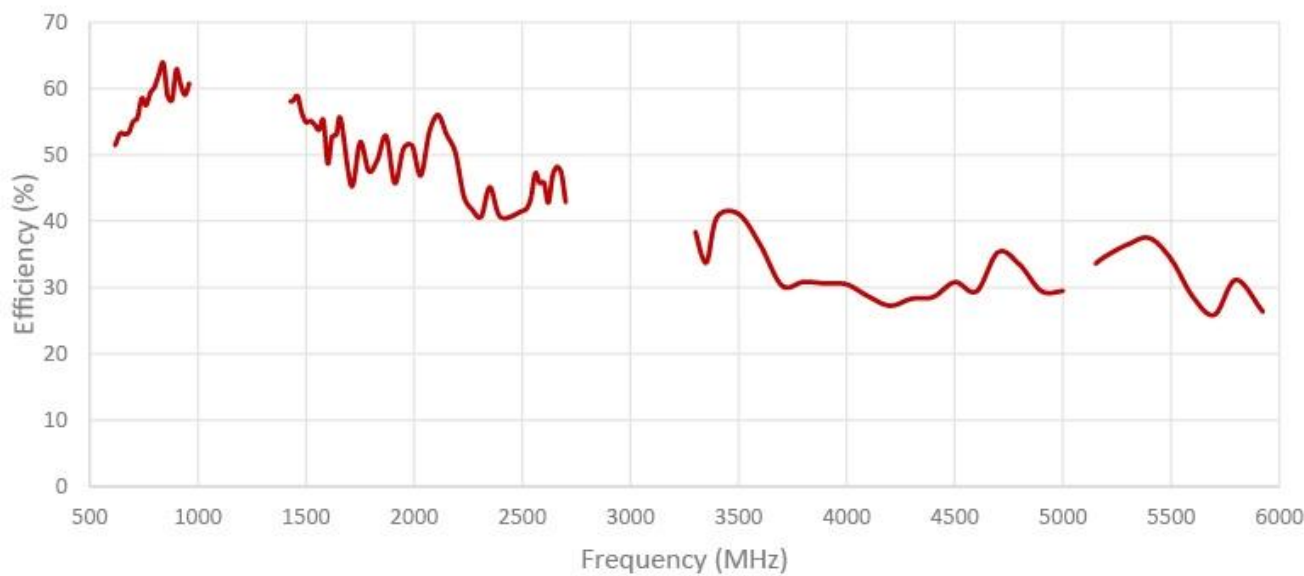
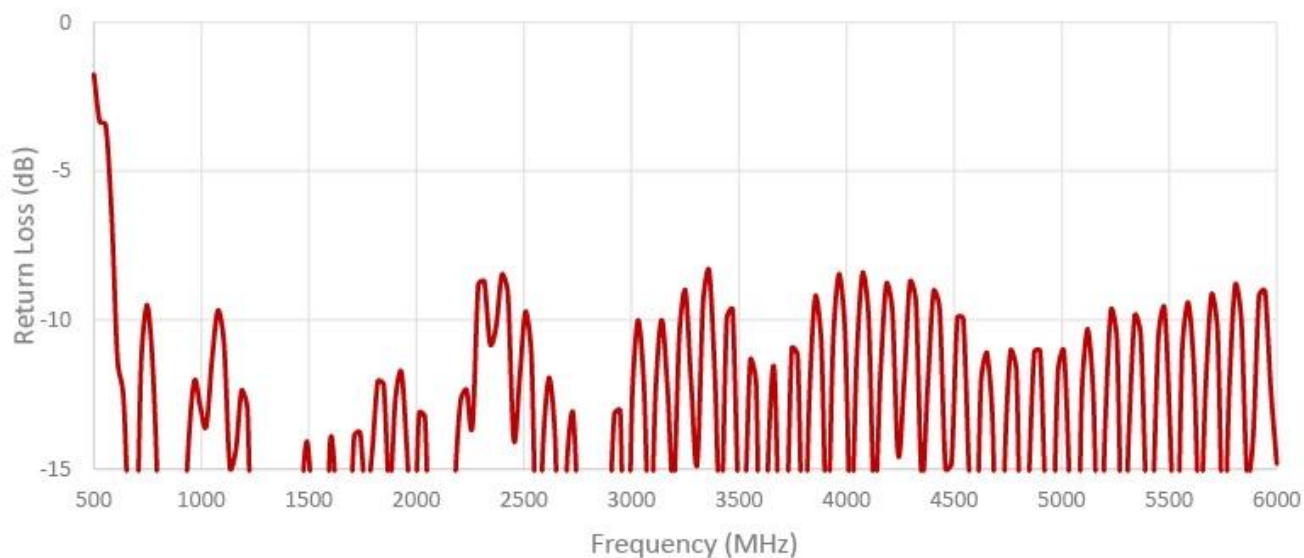

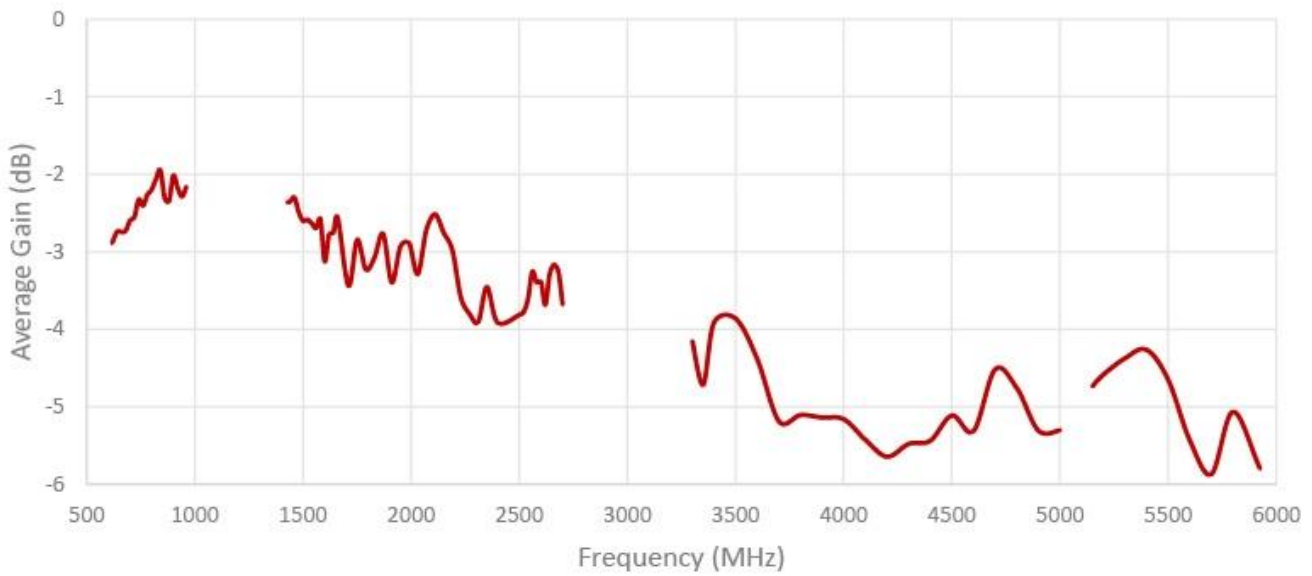
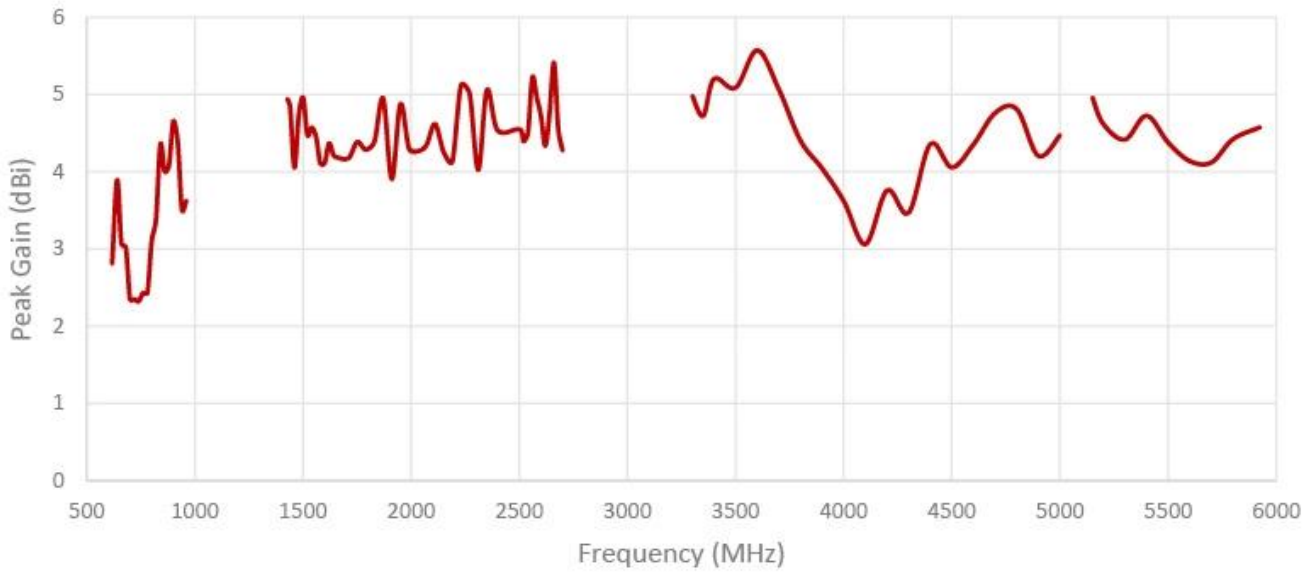



Câble 2 : 2G/3G/4G/5G - IoT/LPWAN

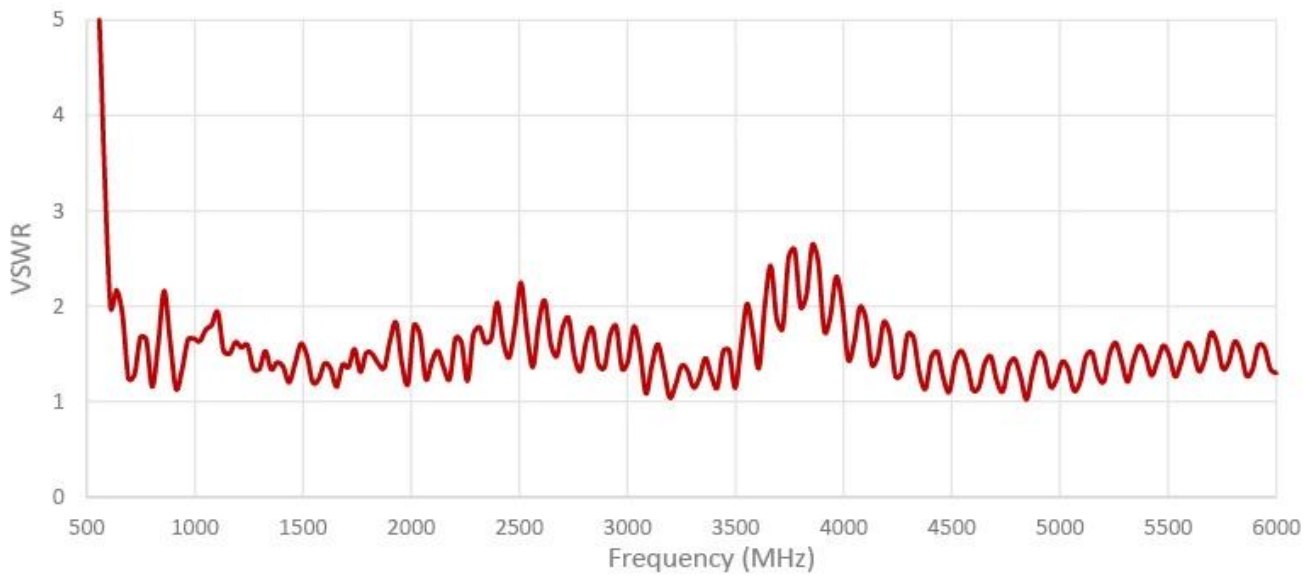
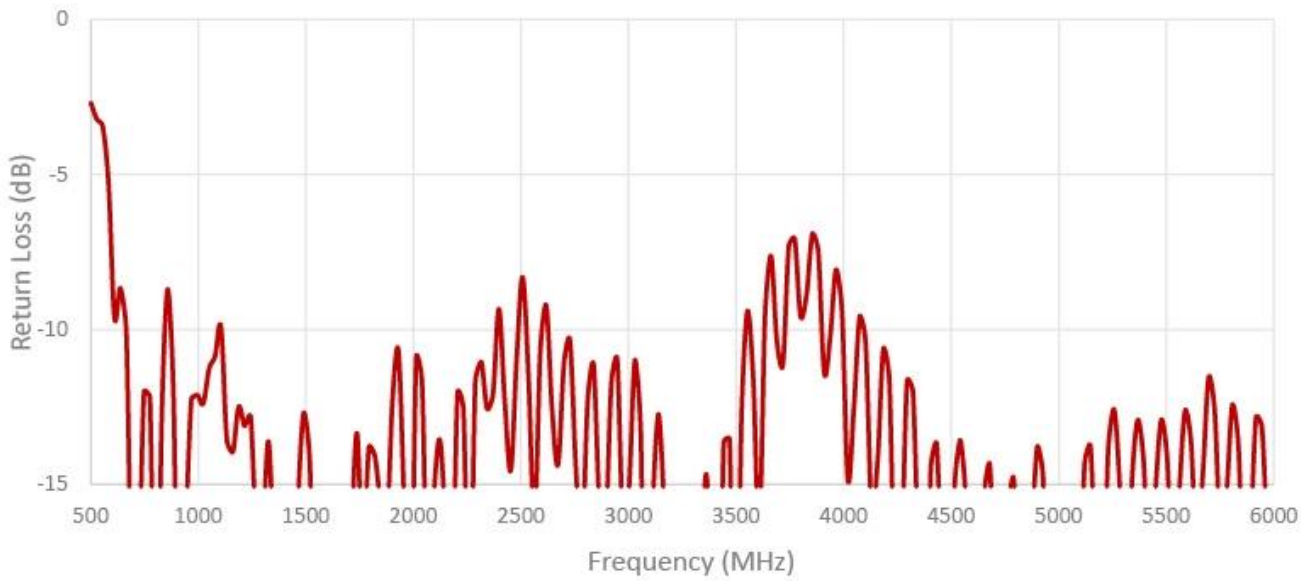

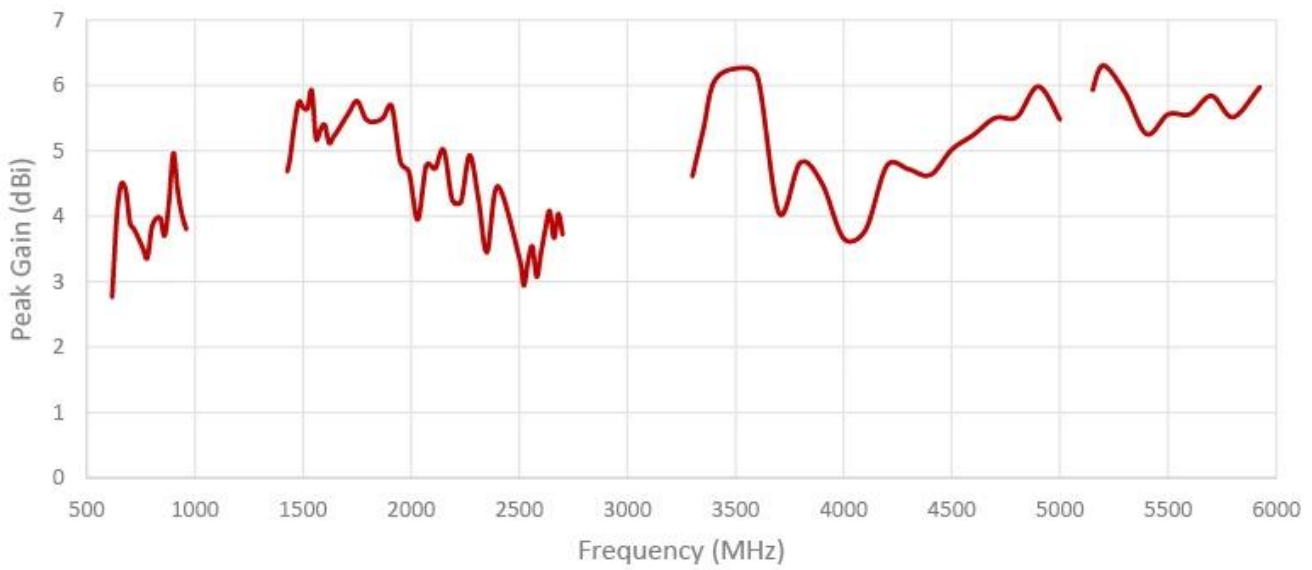
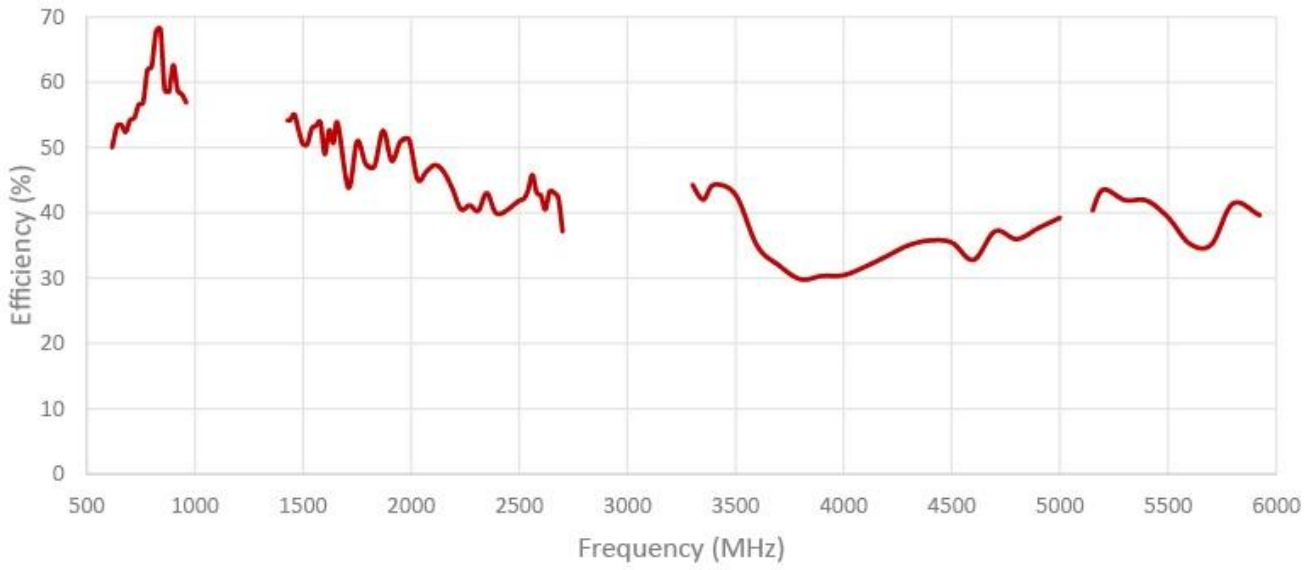

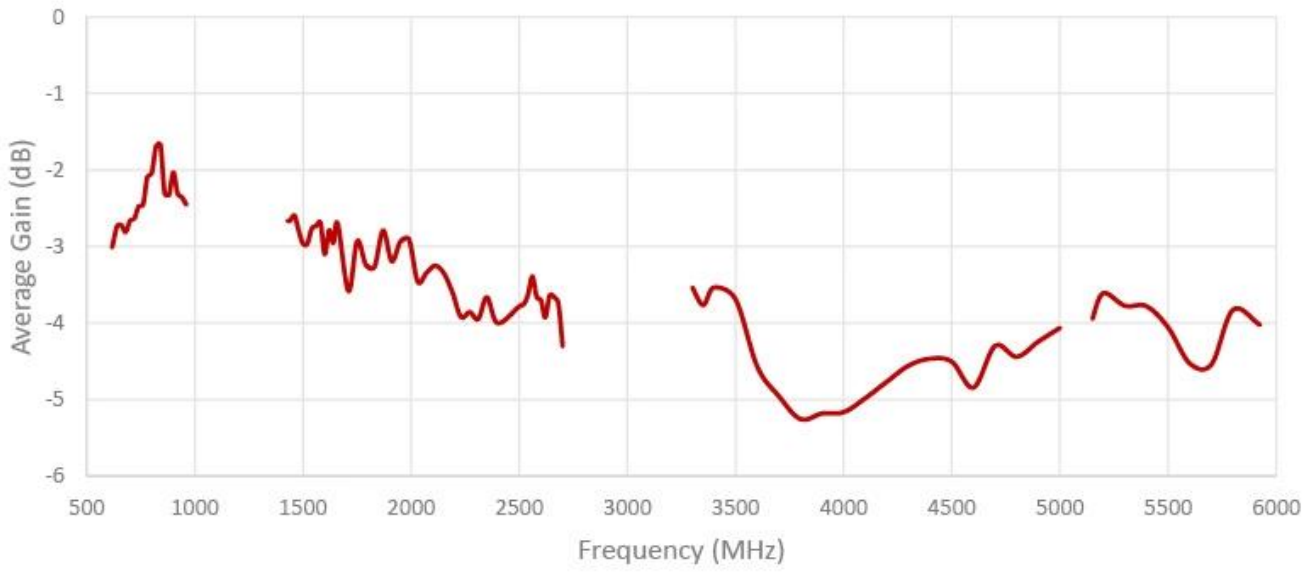

Câble 3 : 2G/3G/4G/5G - IoT/LPWAN

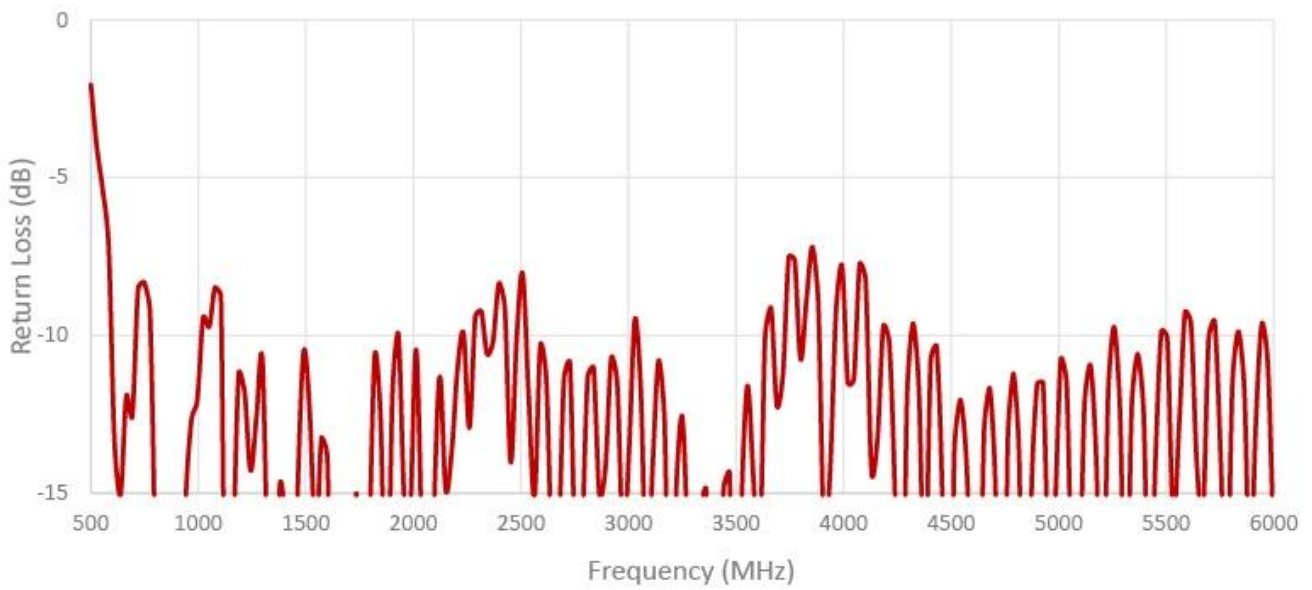

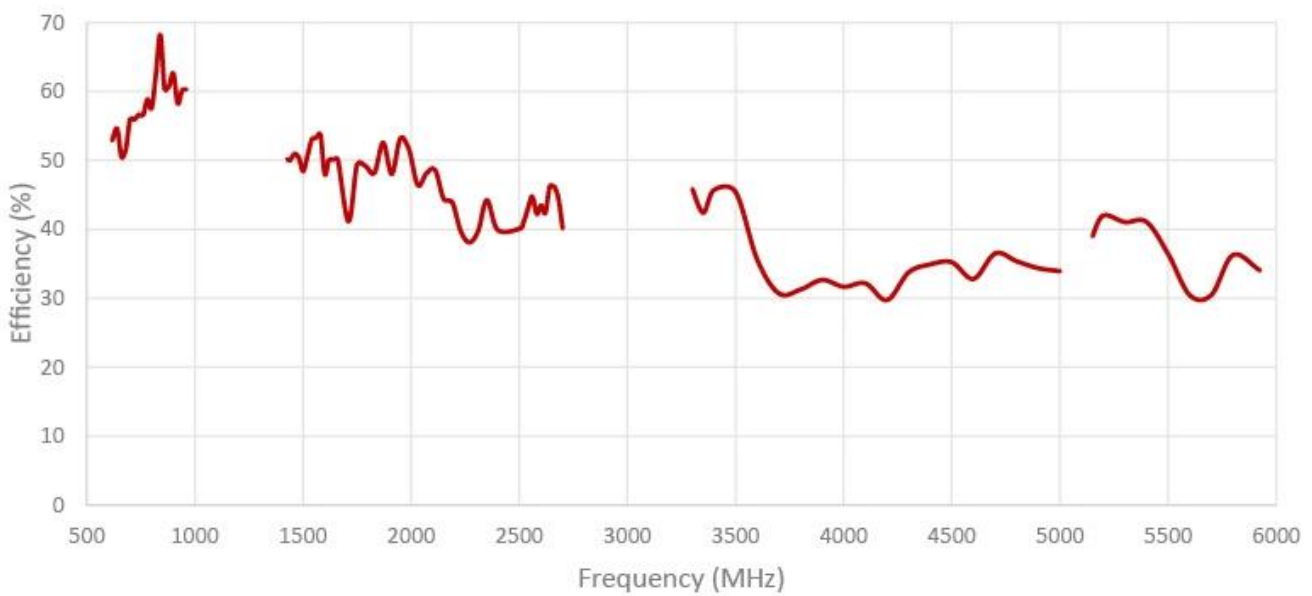
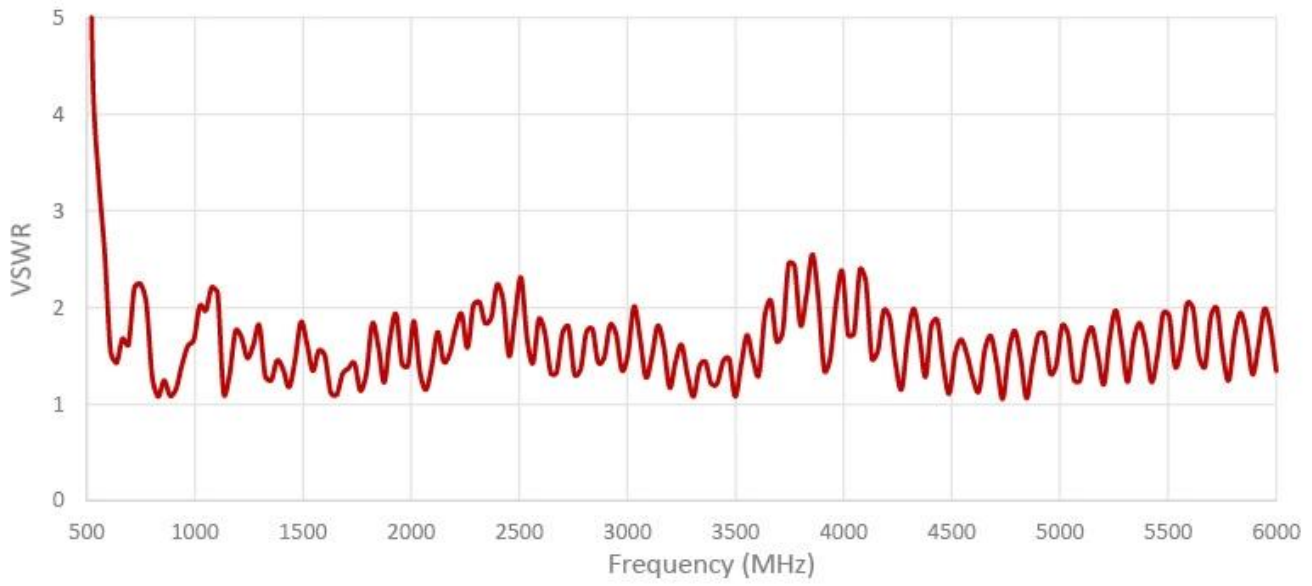

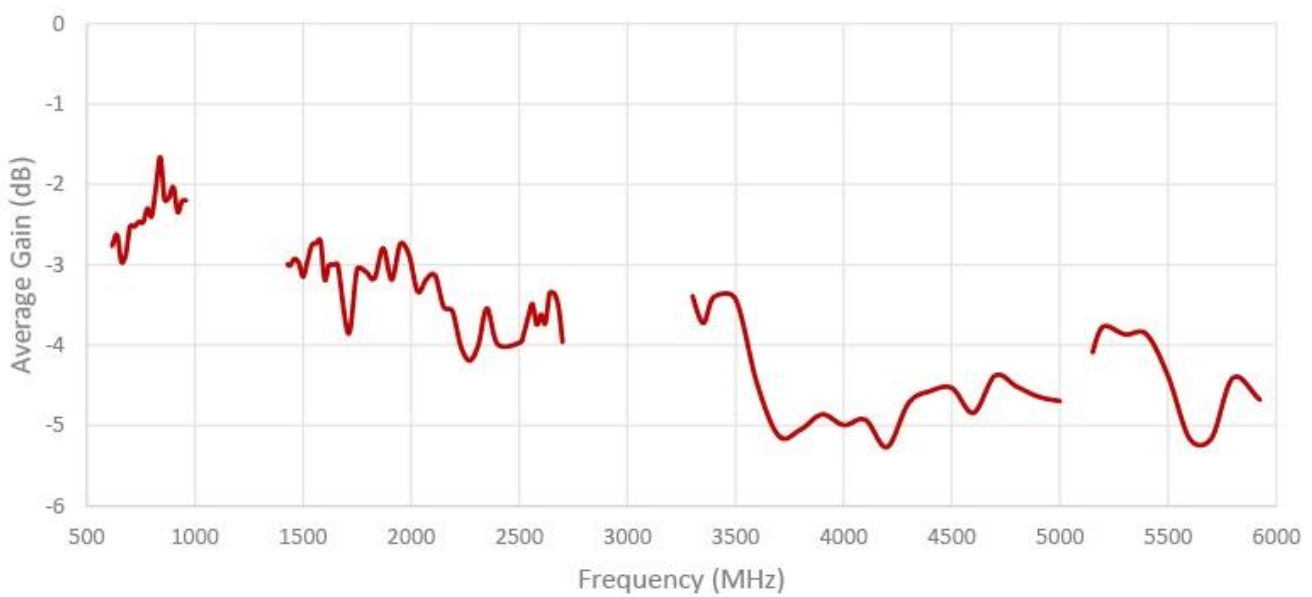
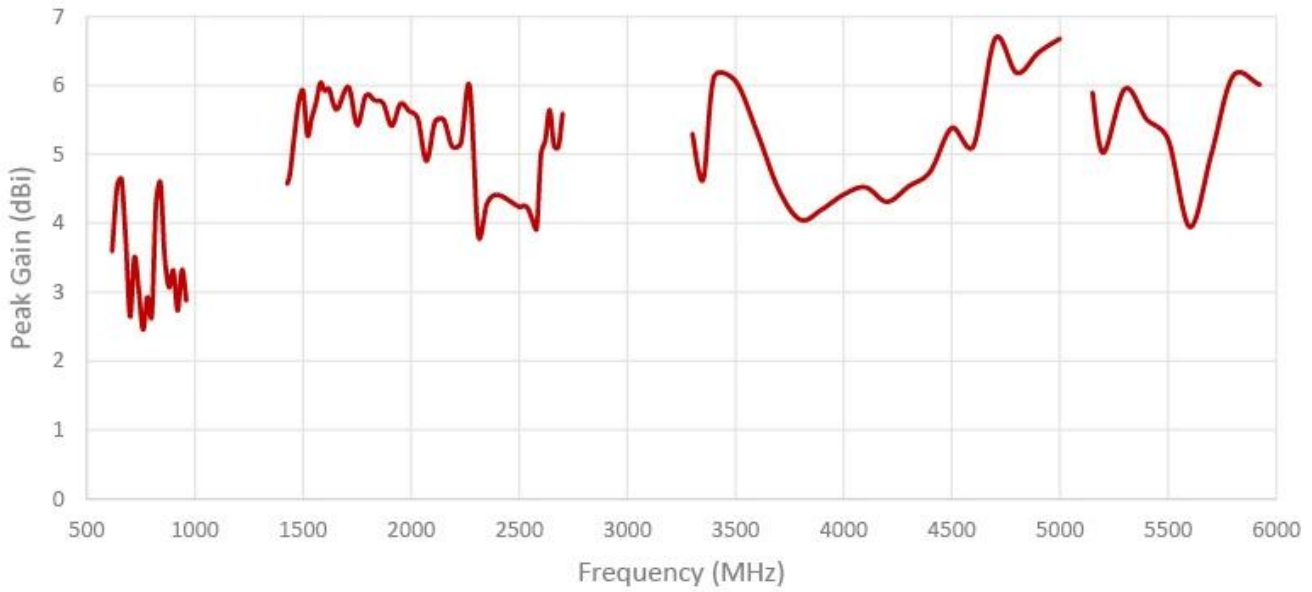



Câble 4 : 2G/3G/4G/5G - IoT/LPWAN

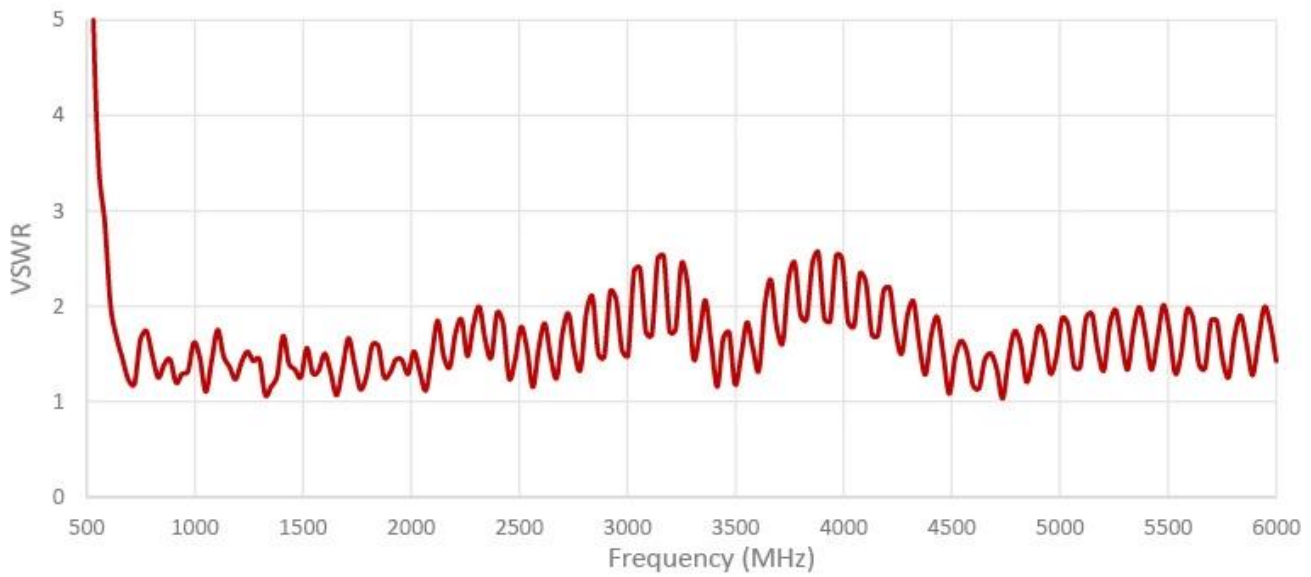
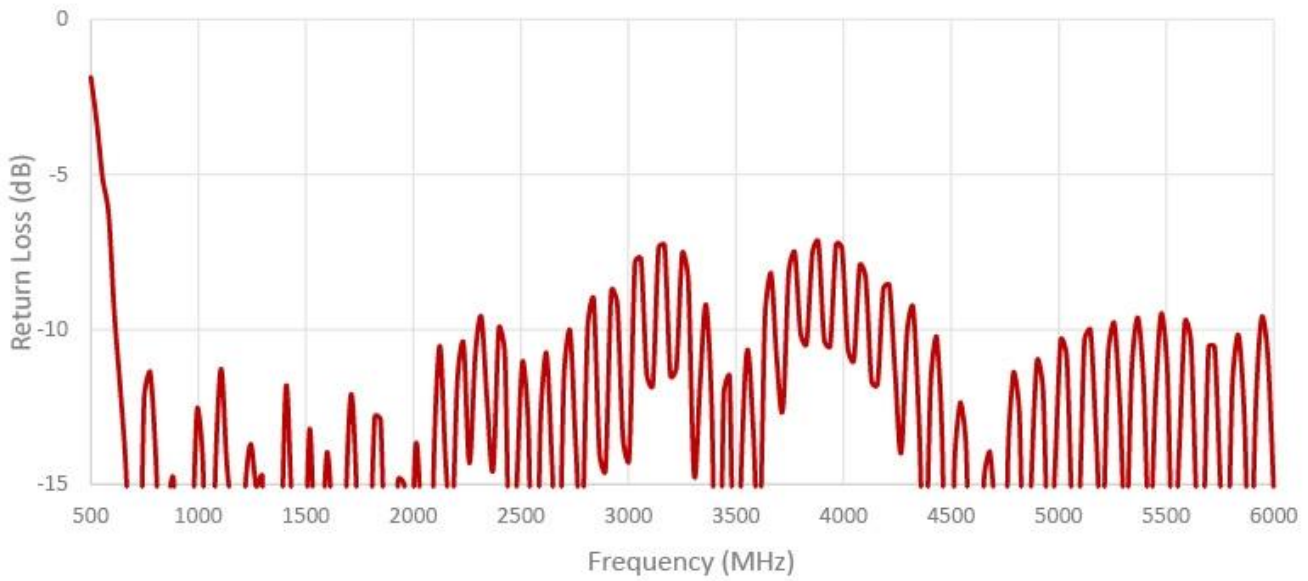

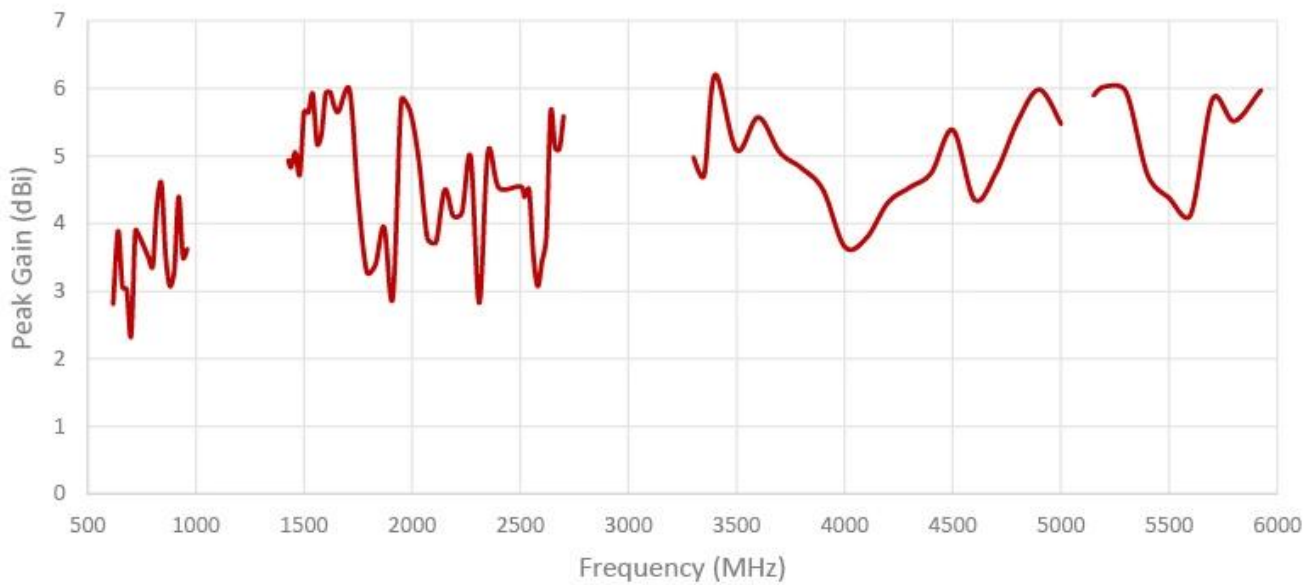
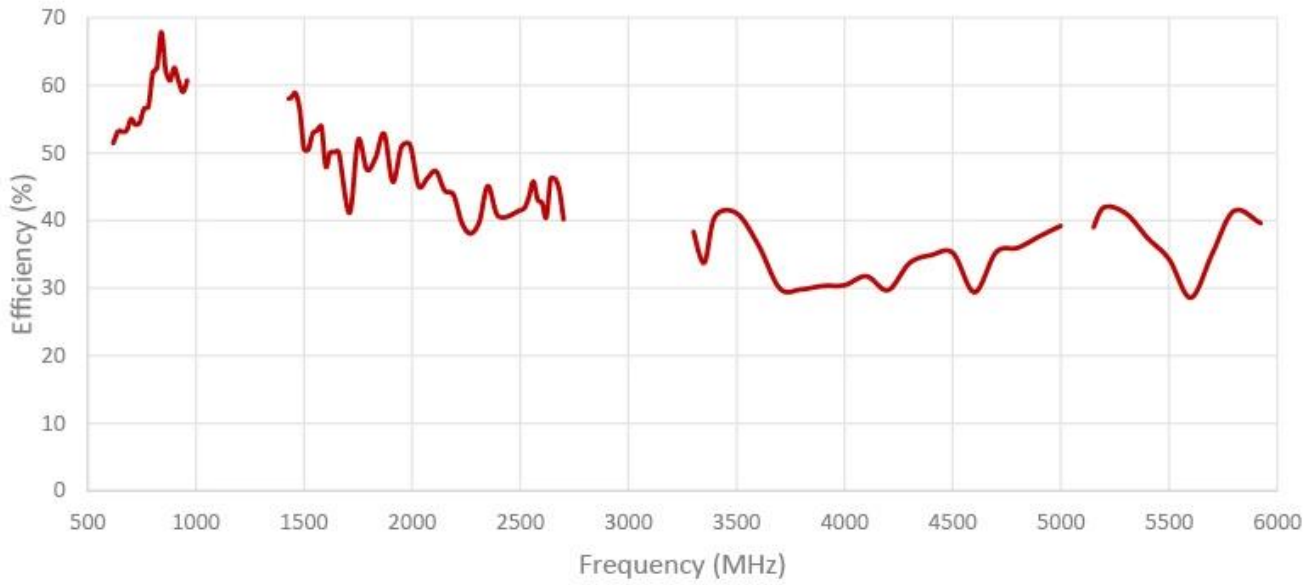

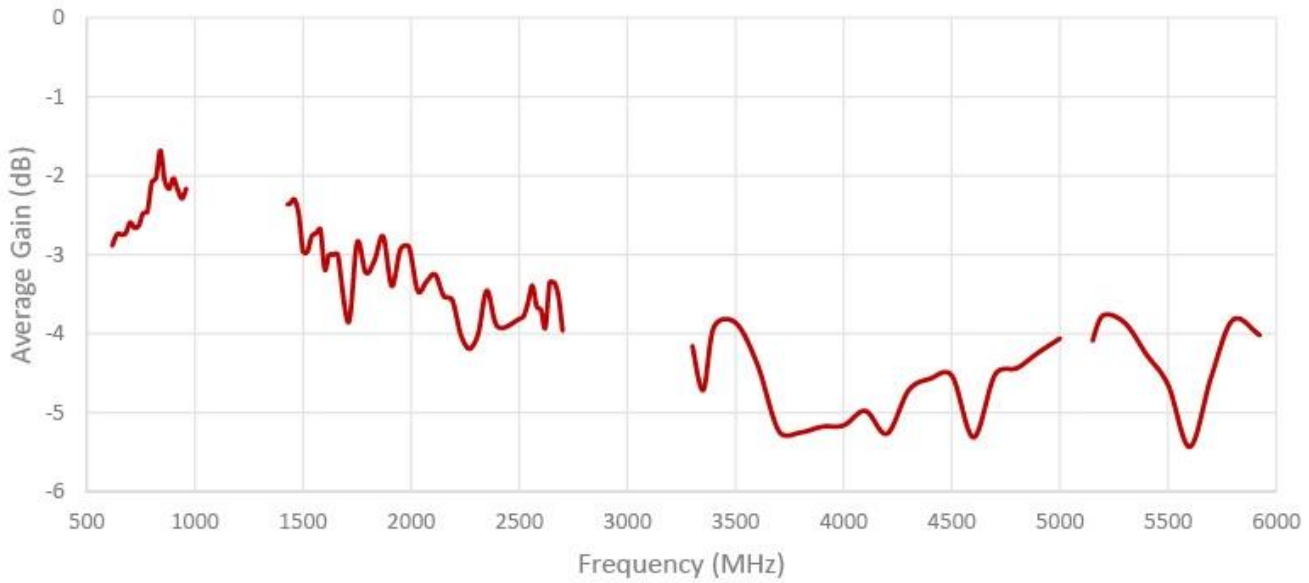

Isolation câble 1 et 2

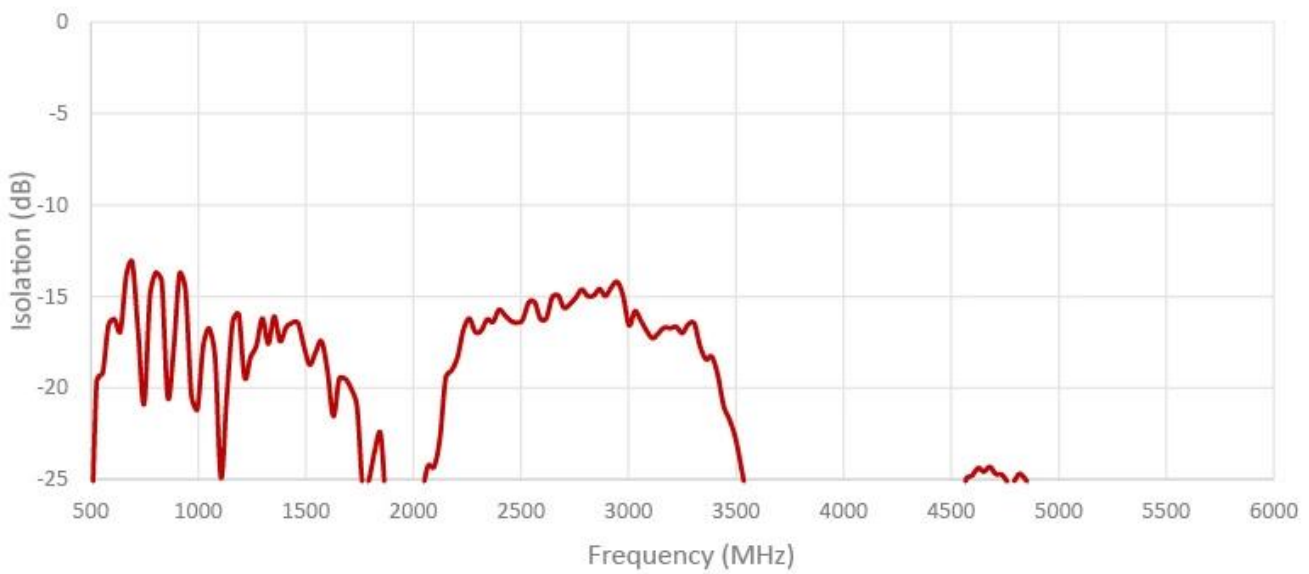



Coefficient de corrélation de l'enveloppe câble 1 et 2

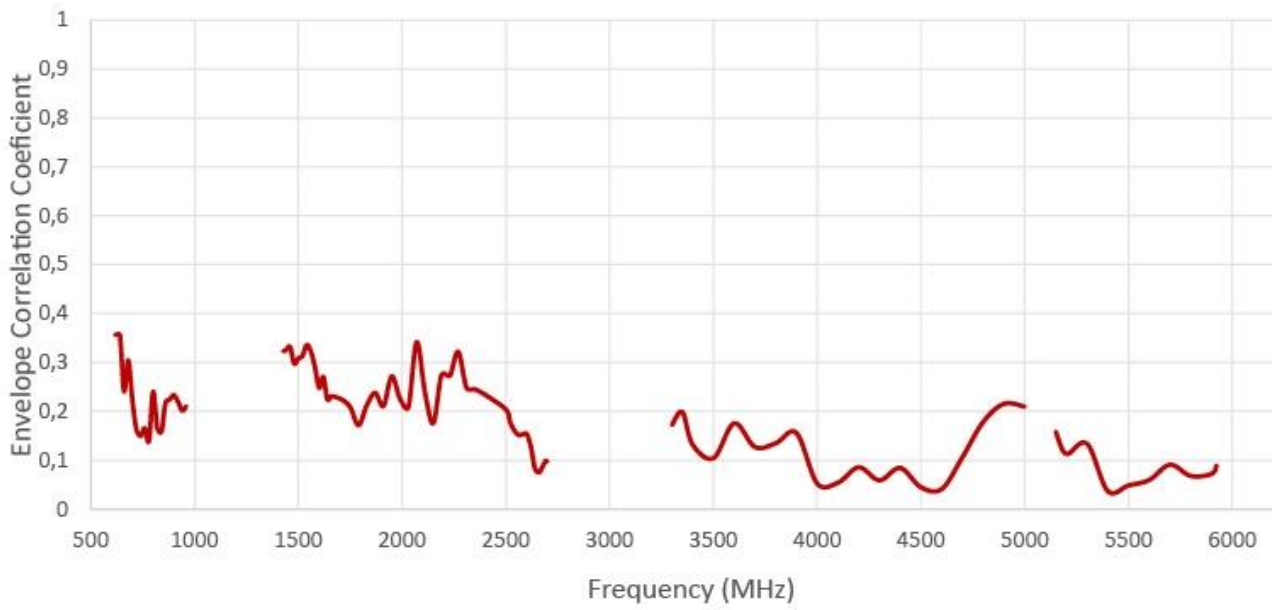

Isolation câble 1 et 3

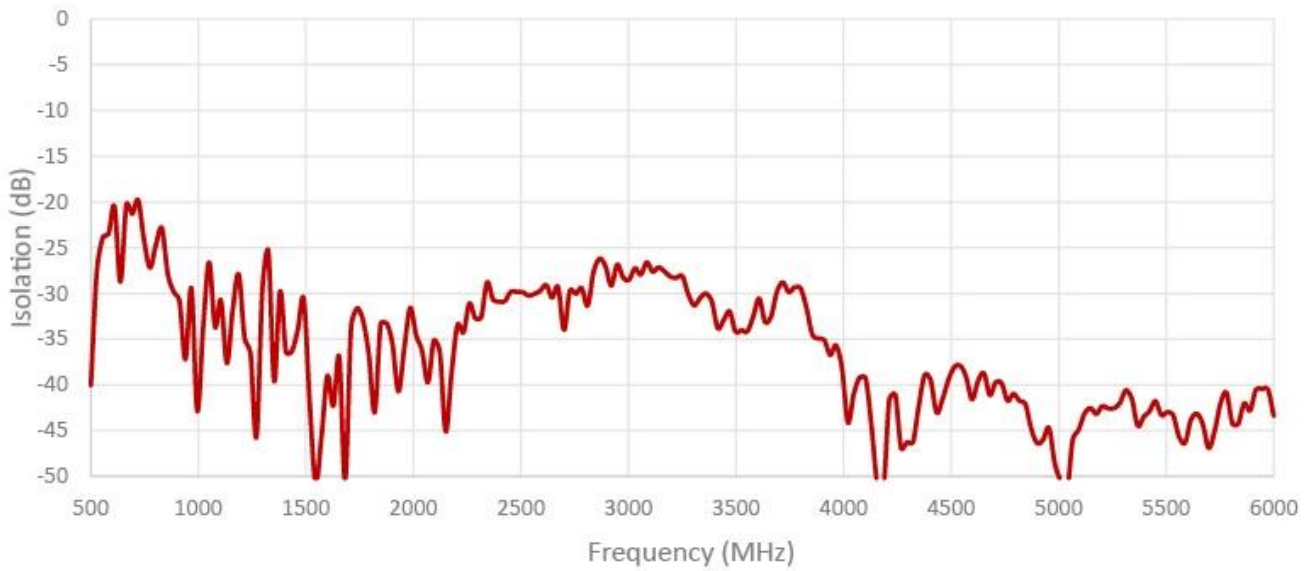



Coefficient de corrélation de l'enveloppe câble 1 et 3

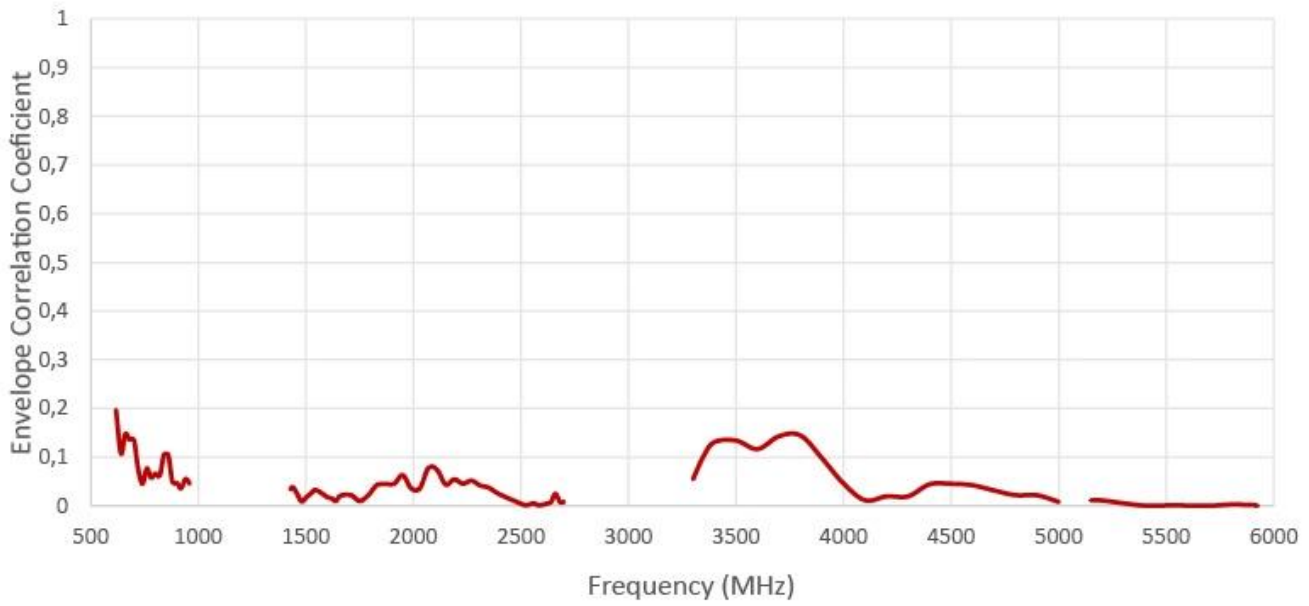

Isolation câble 1 et 4

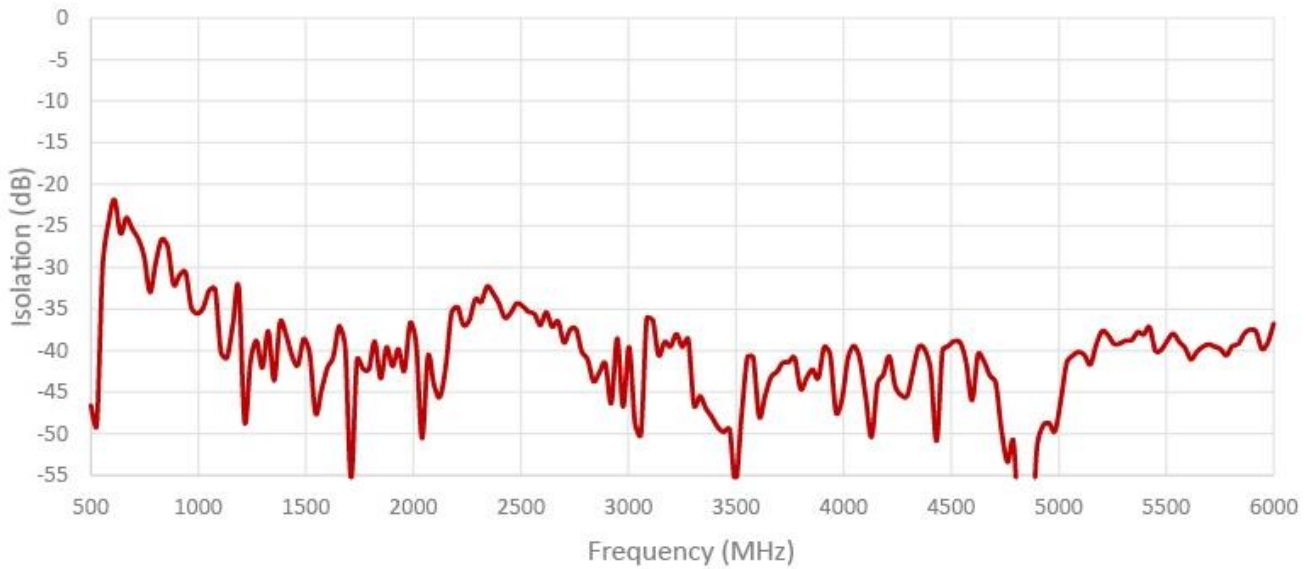



Coefficient de corrélation de l'enveloppe câble 1 et 4

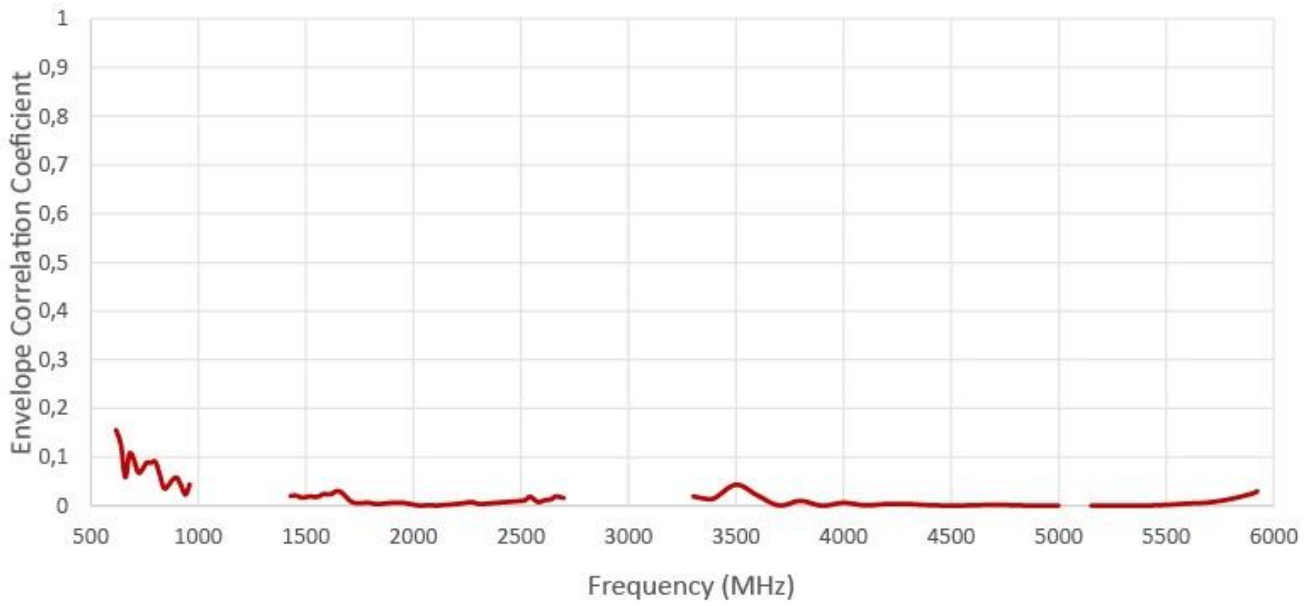

Isolation câble 2 et 3

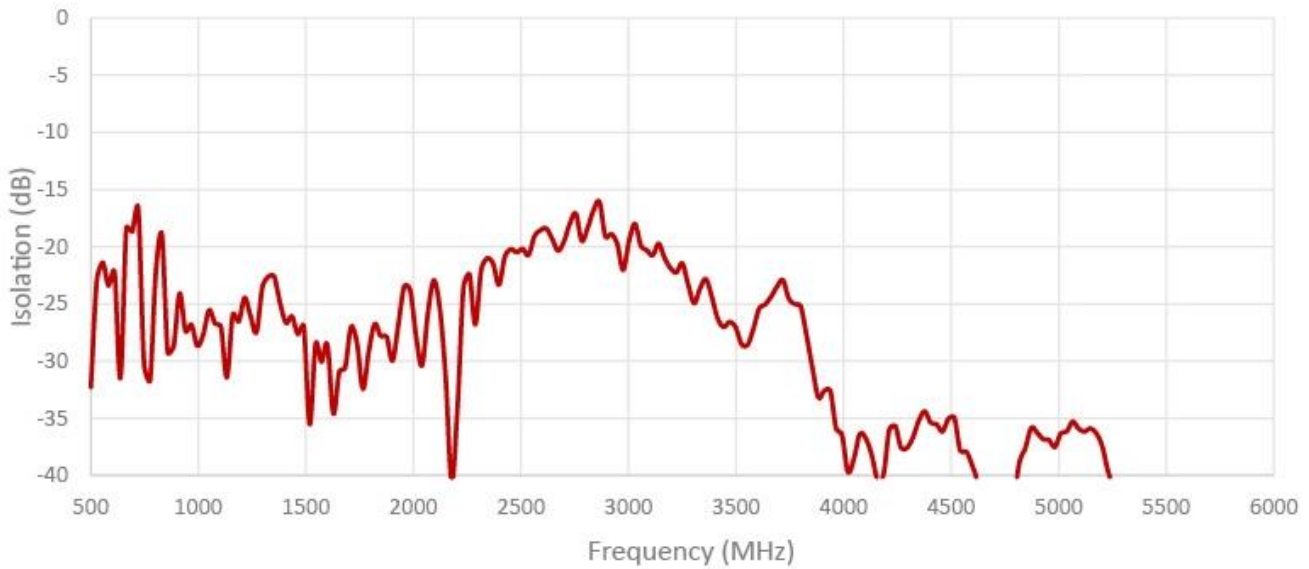



Coefficient de corrélation de l'enveloppe câble 2 et 3

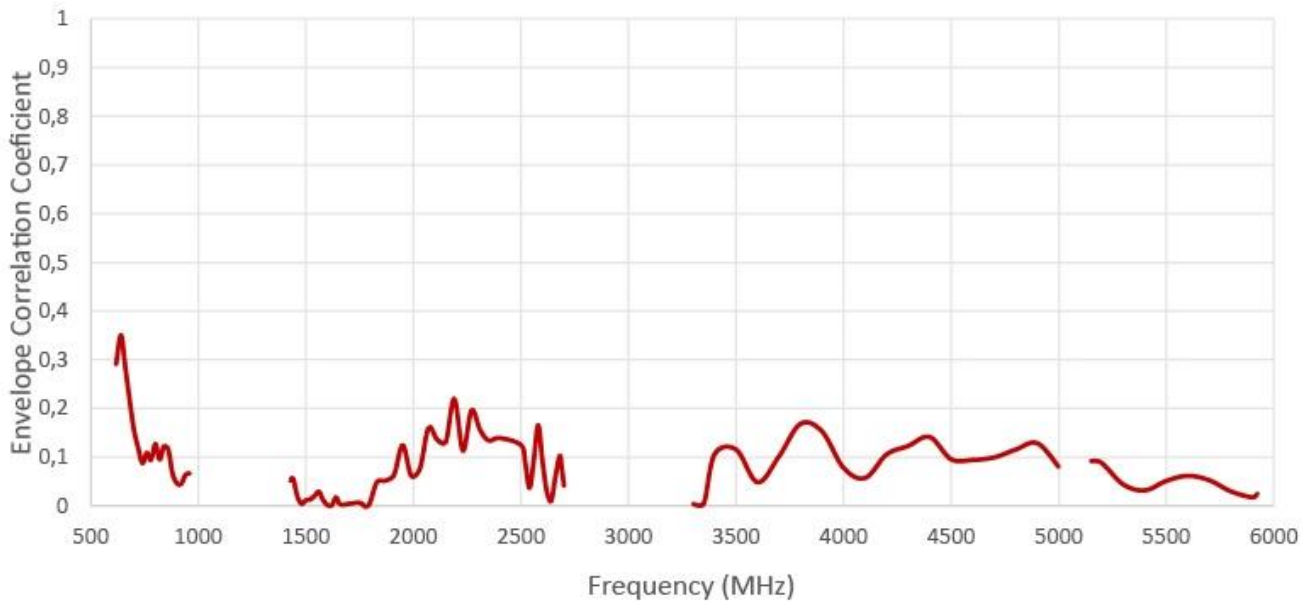

Câble 5 : ISM 2,4 / 5.0 / 6.0 GHz – WiFi, Bluetooth, ZigBee

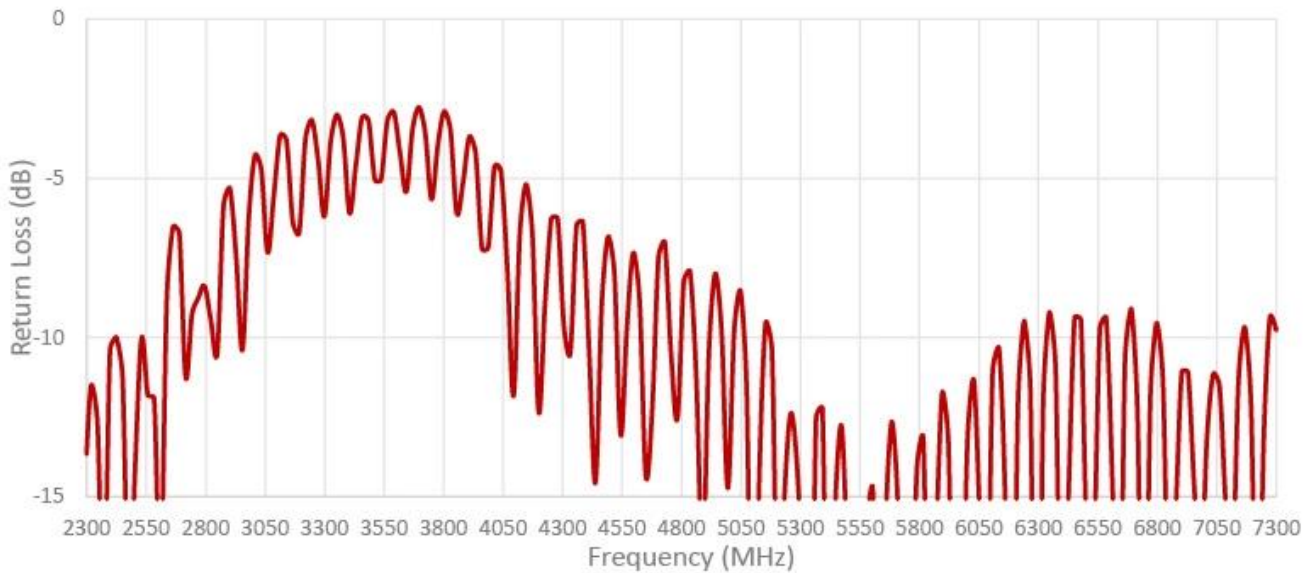

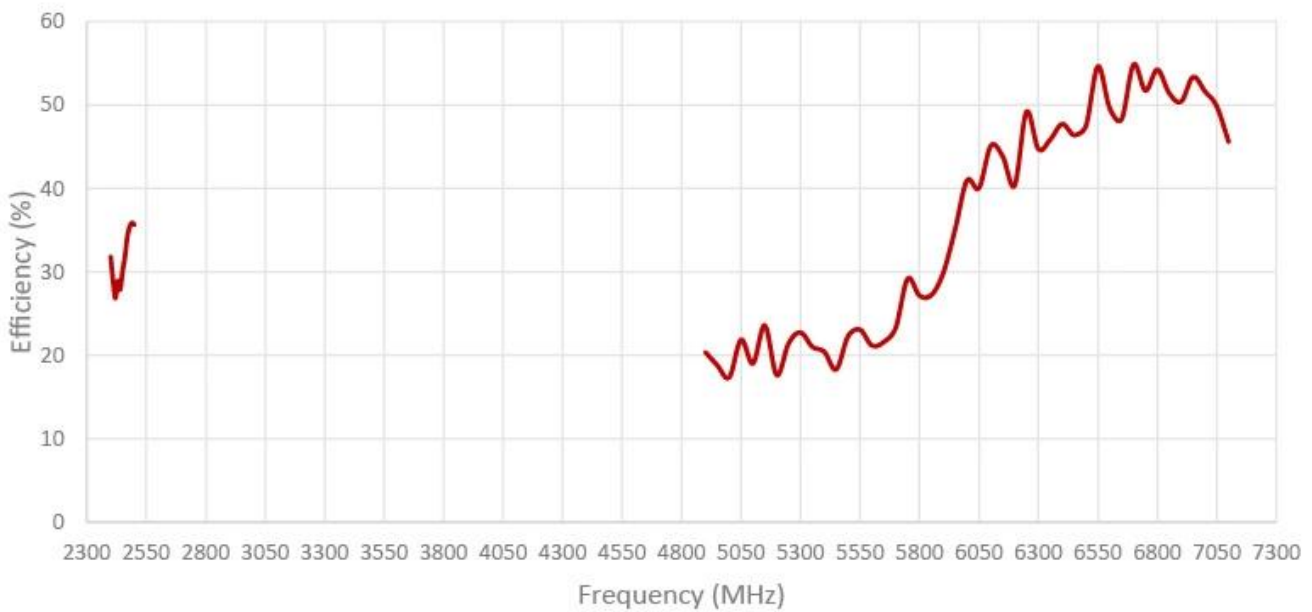
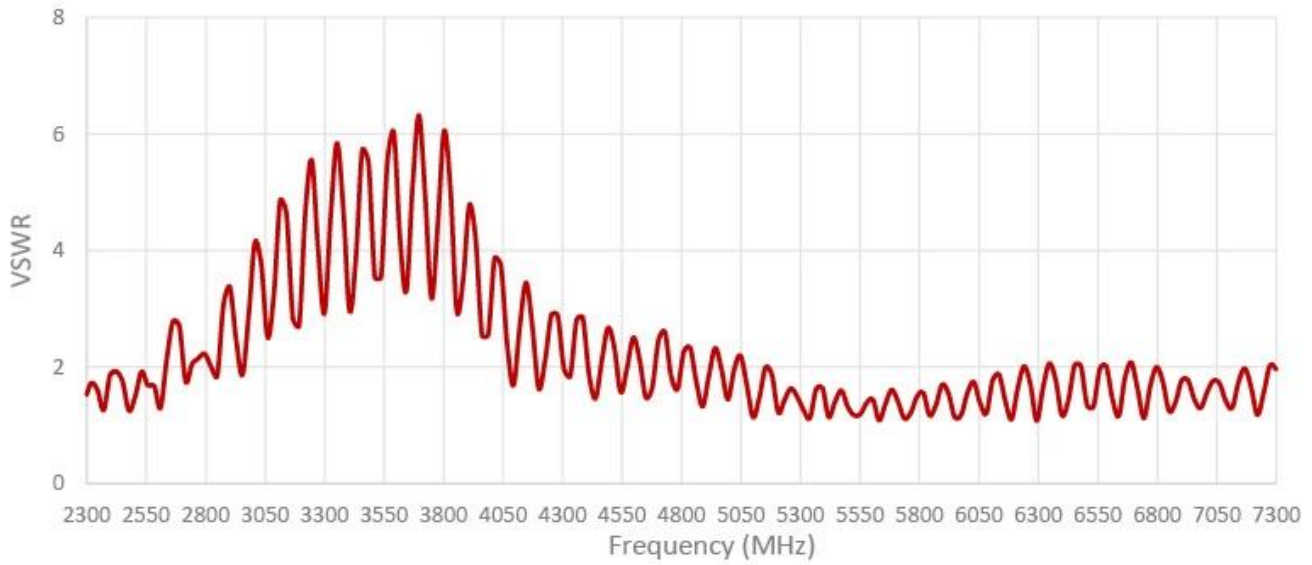

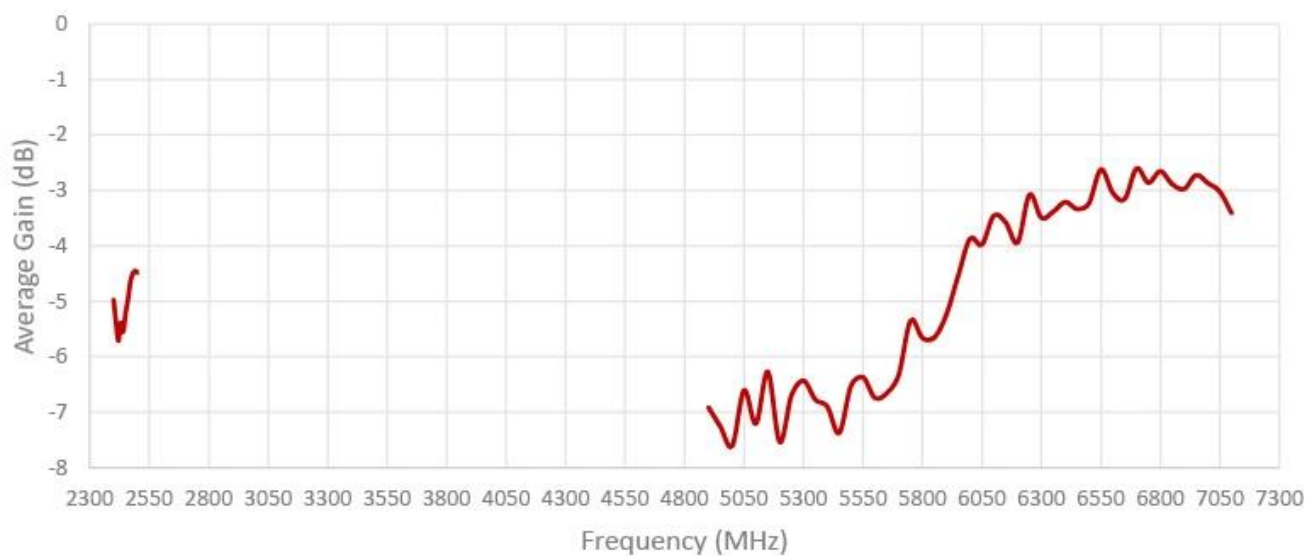
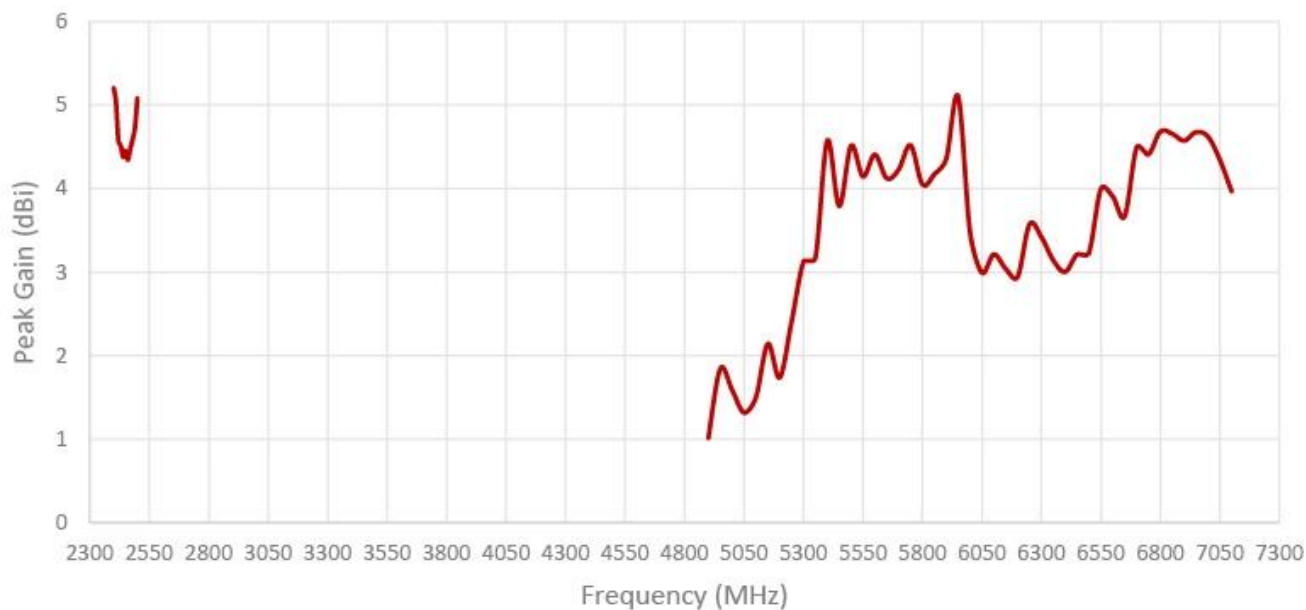



Câble 6 : ISM 2,4 / 5.0 / 6.0 GHz – WiFi, Bluetooth, ZigBee

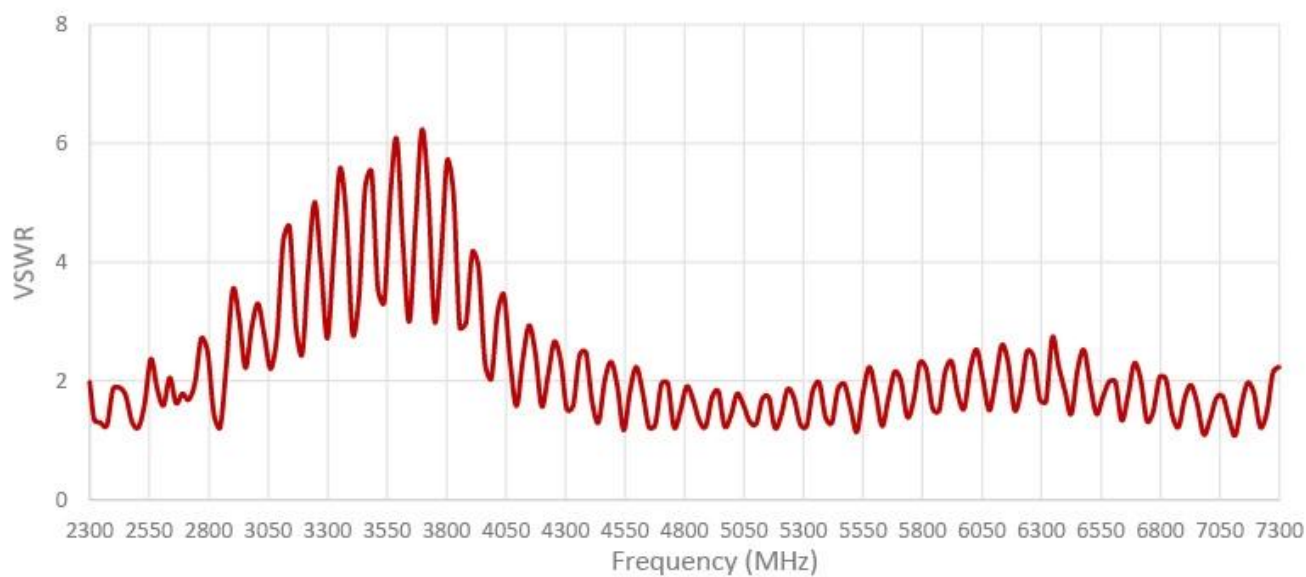
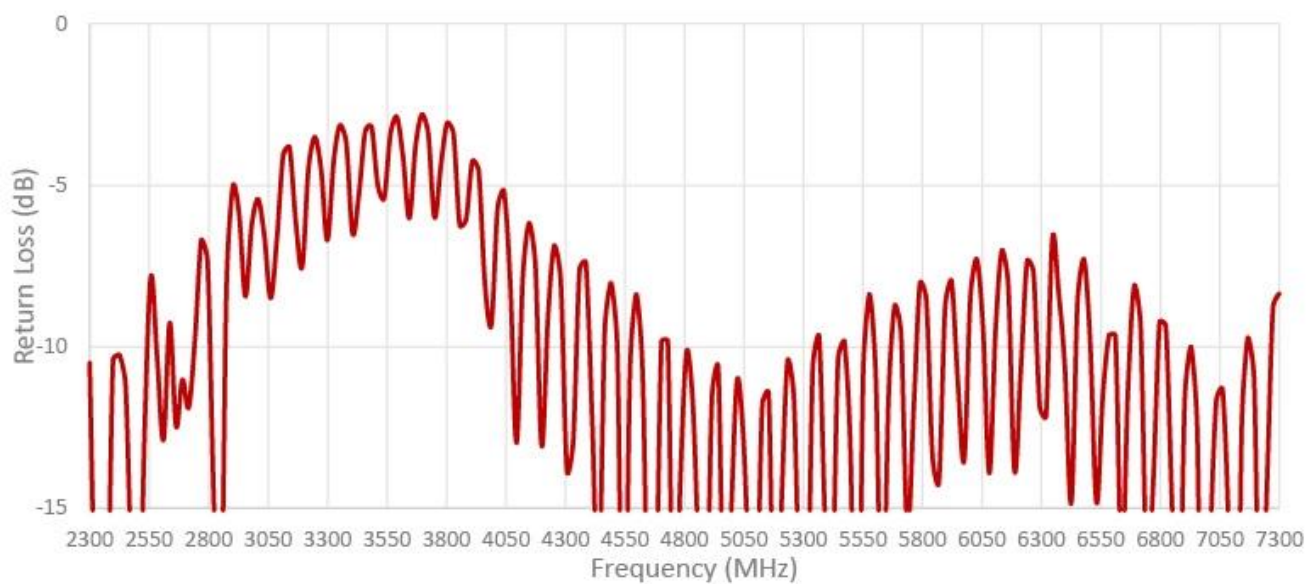

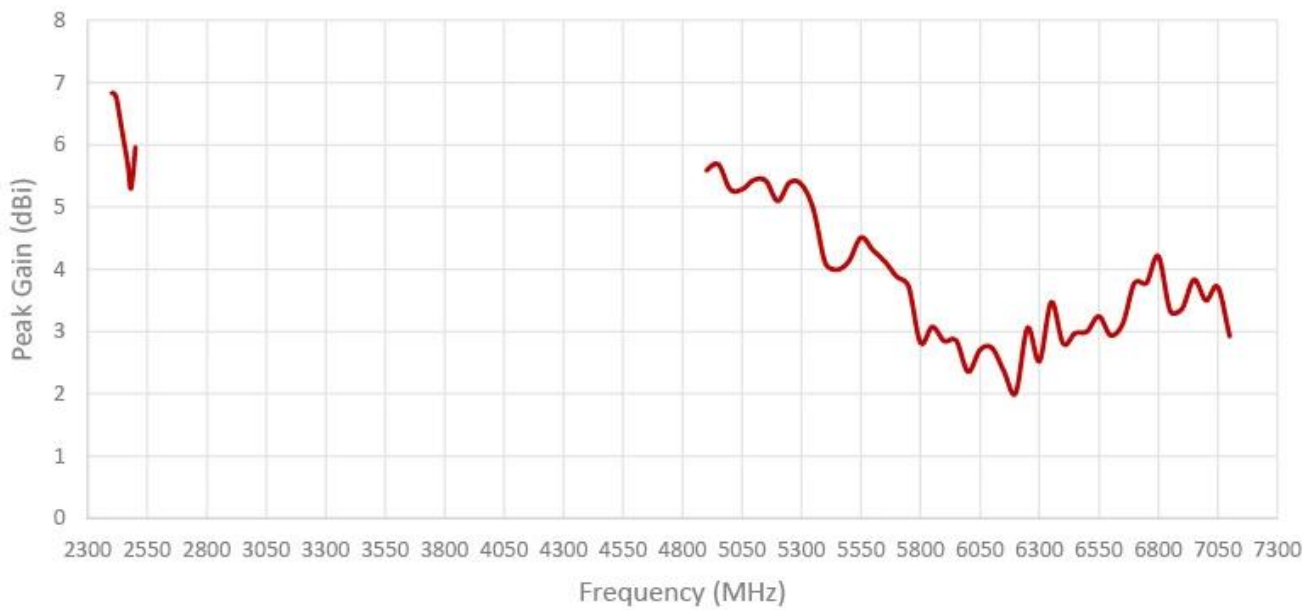
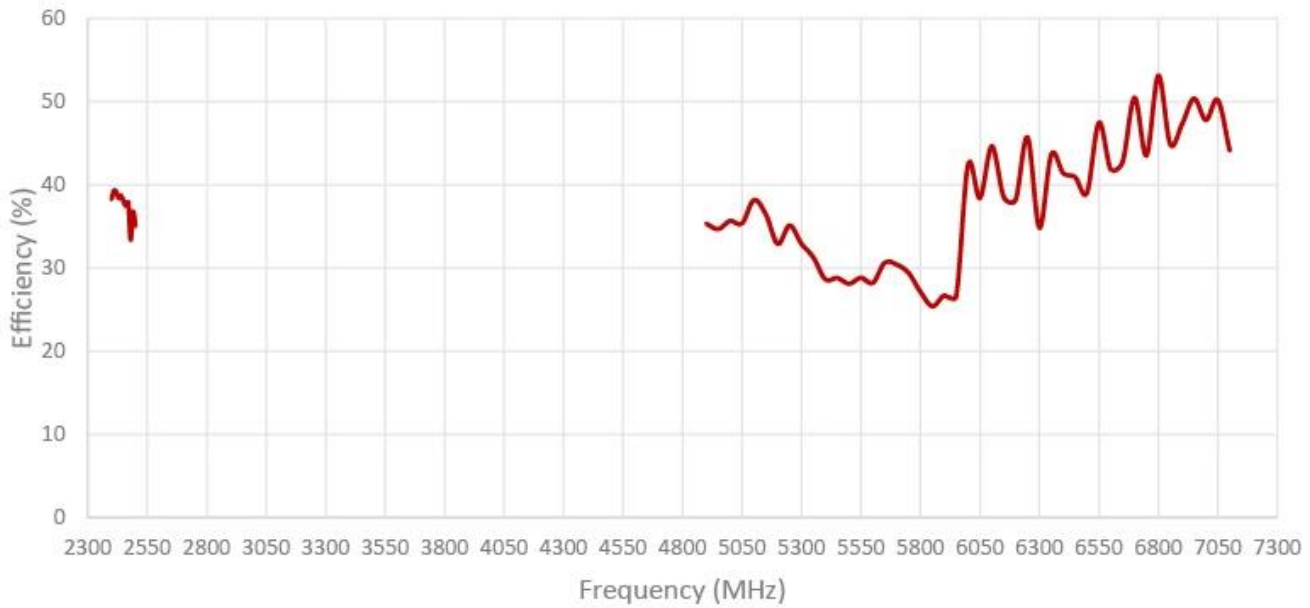



Câble 7 : ISM 2,4 / 5.0 / 6.0 GHz – WiFi, Bluetooth, ZigBee

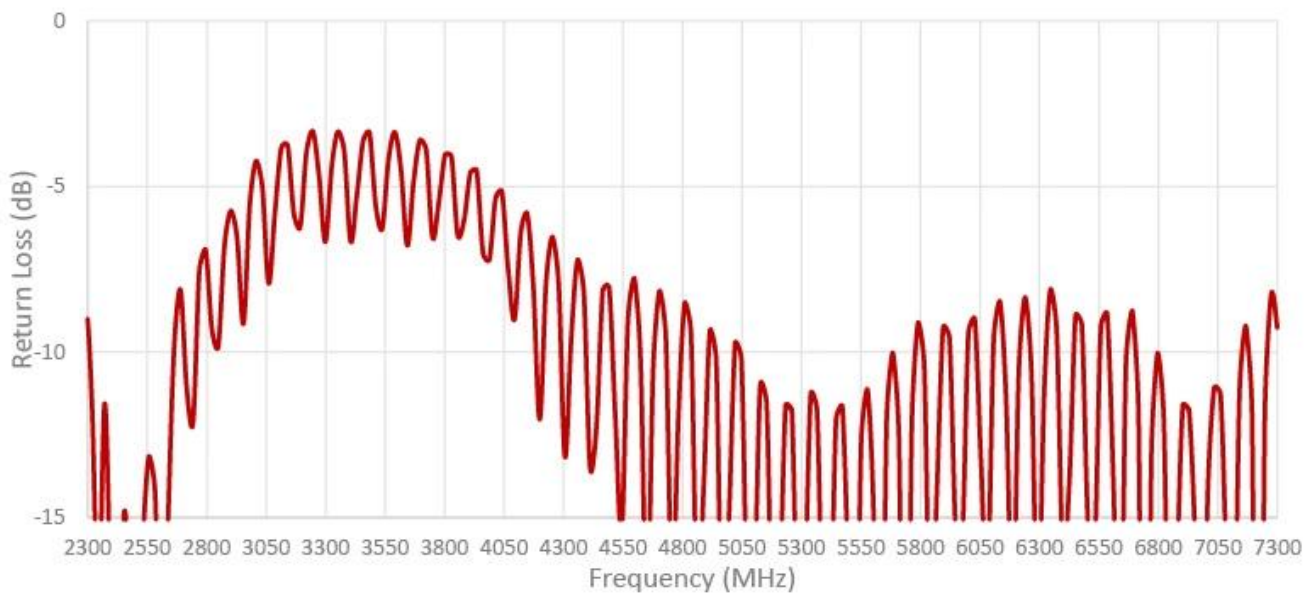

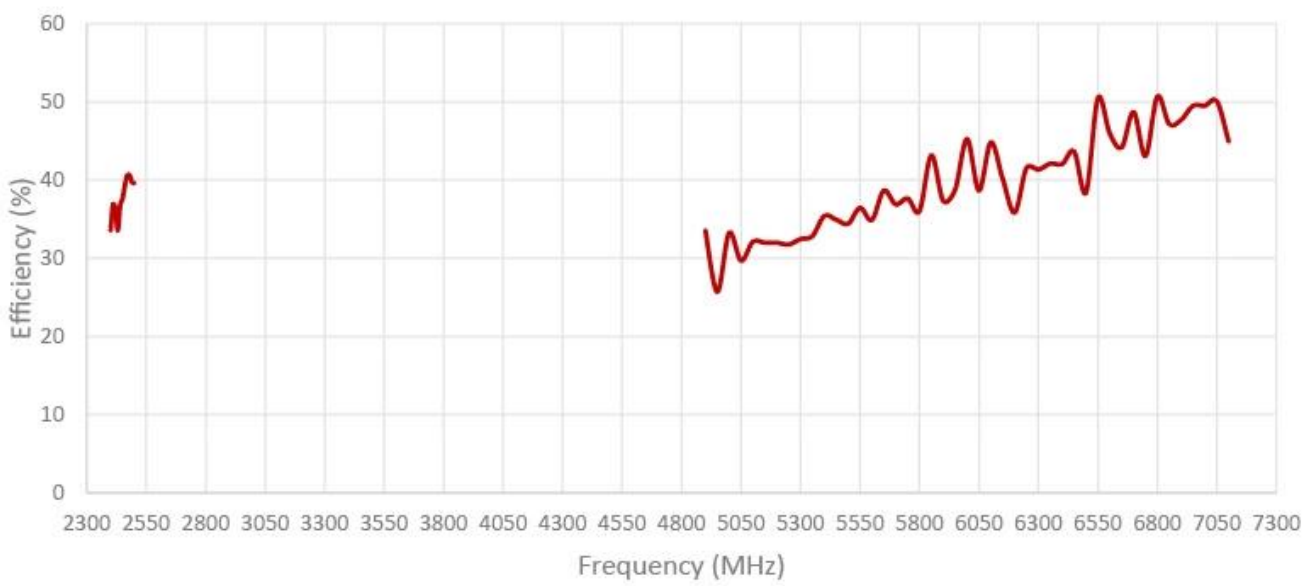
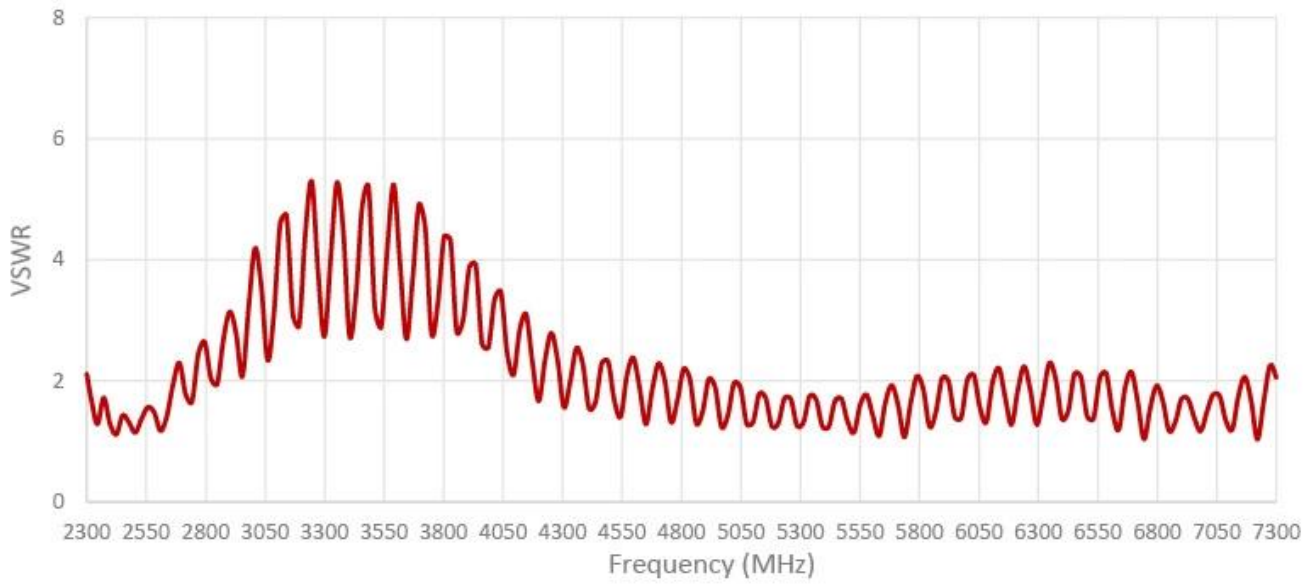

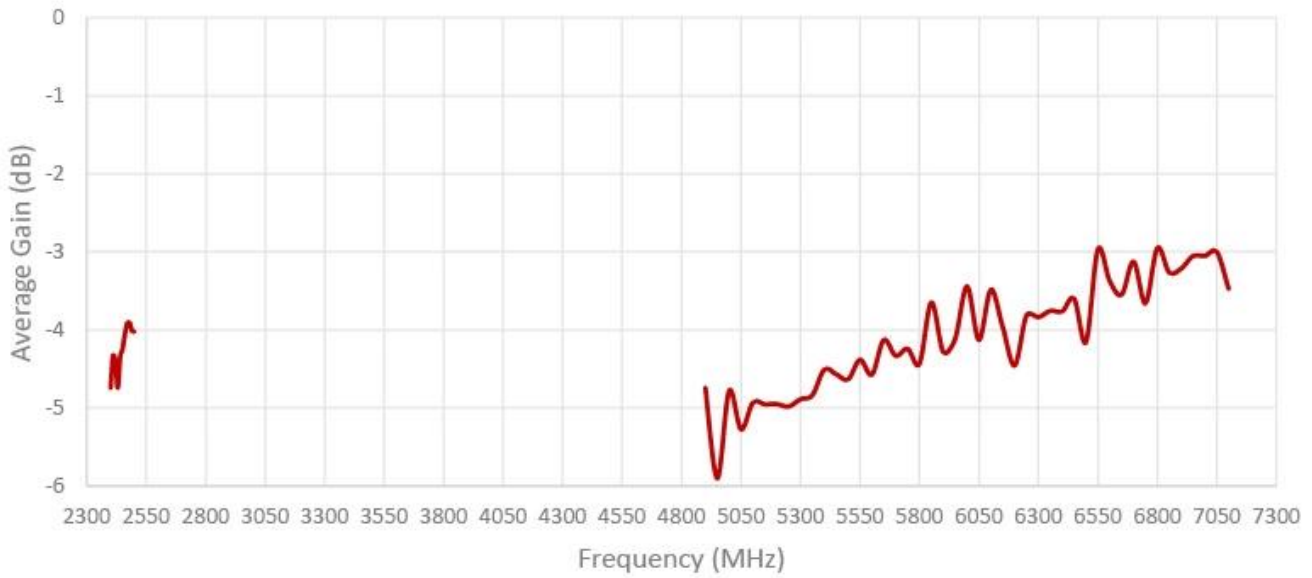
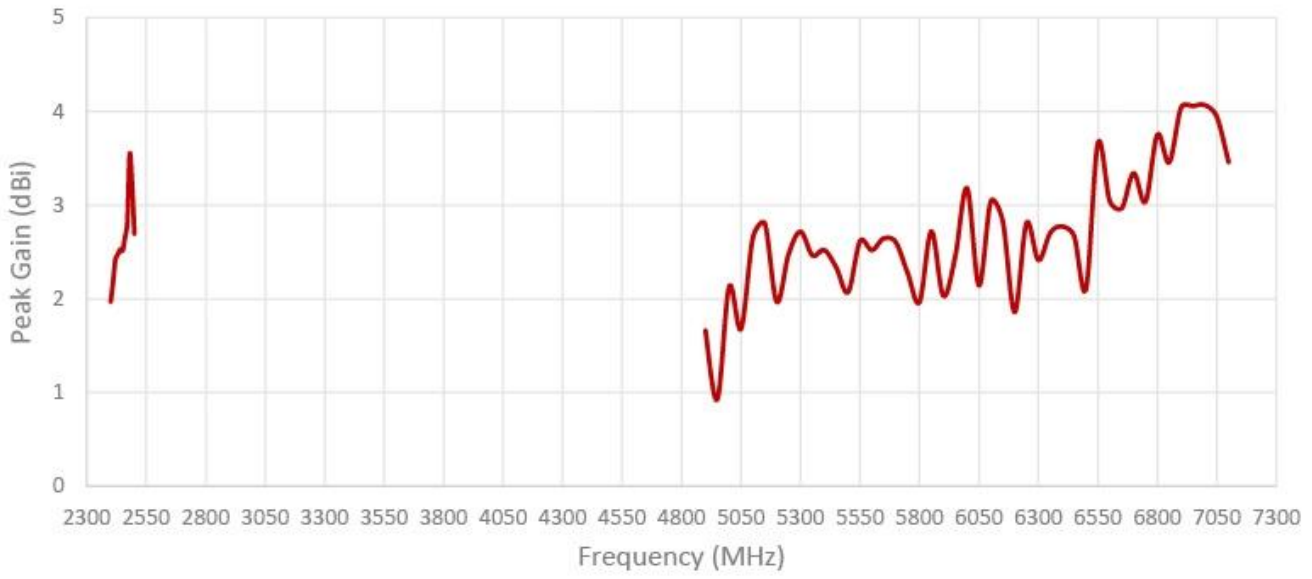



Câble 8 : ISM 2,4 / 5.0 / 6.0 GHz – WiFi, Bluetooth, ZigBee

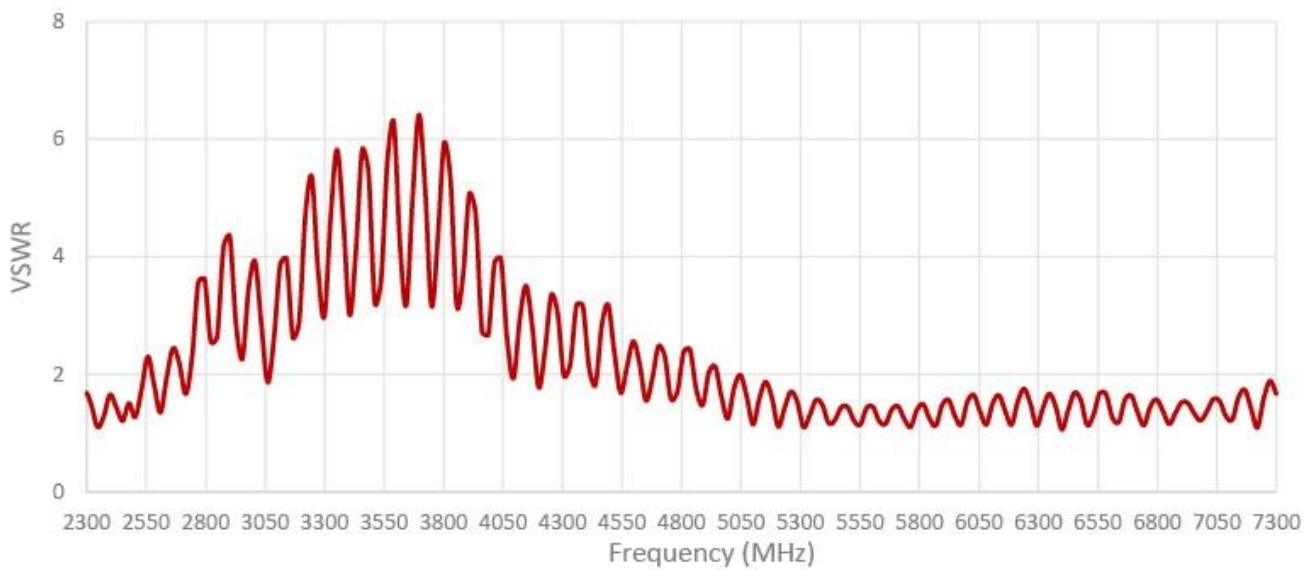
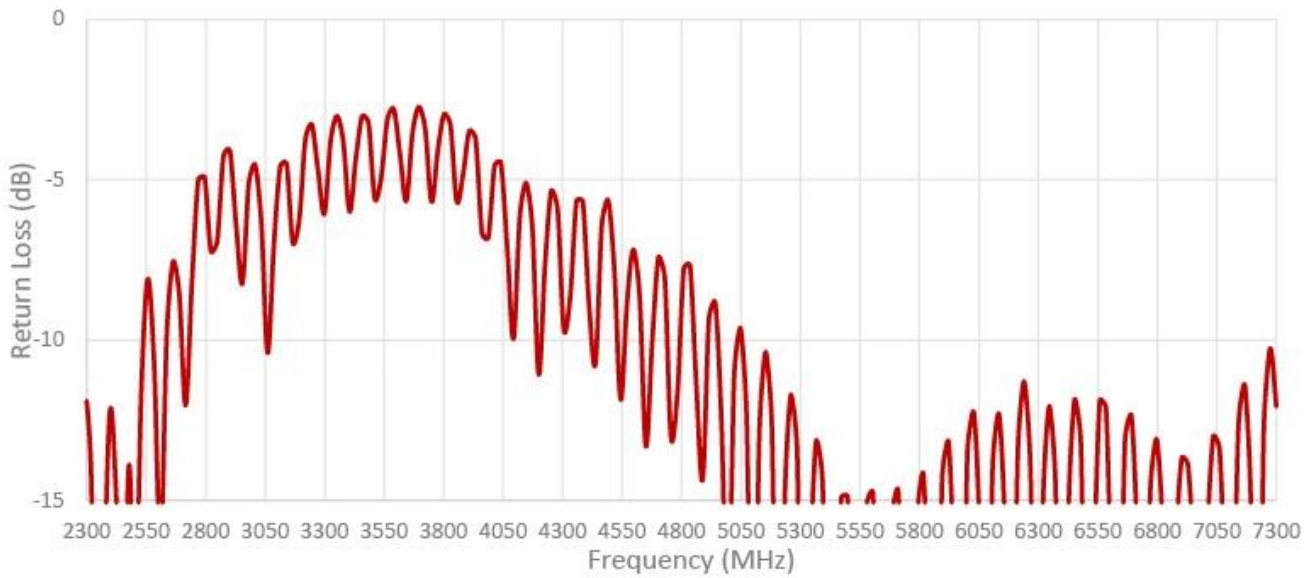

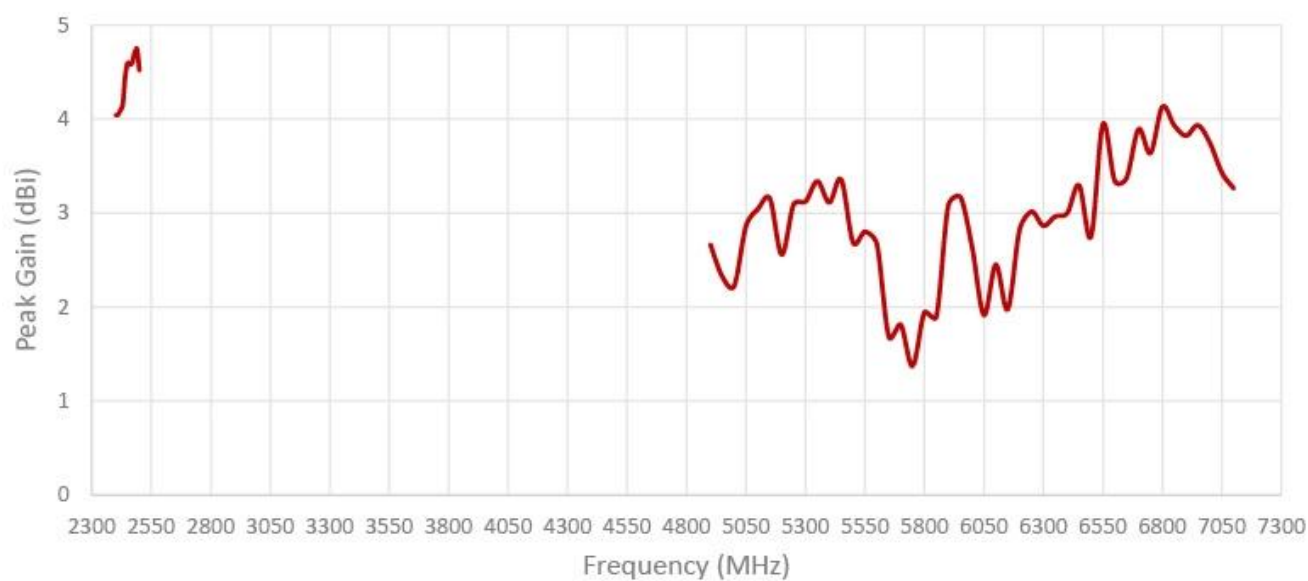
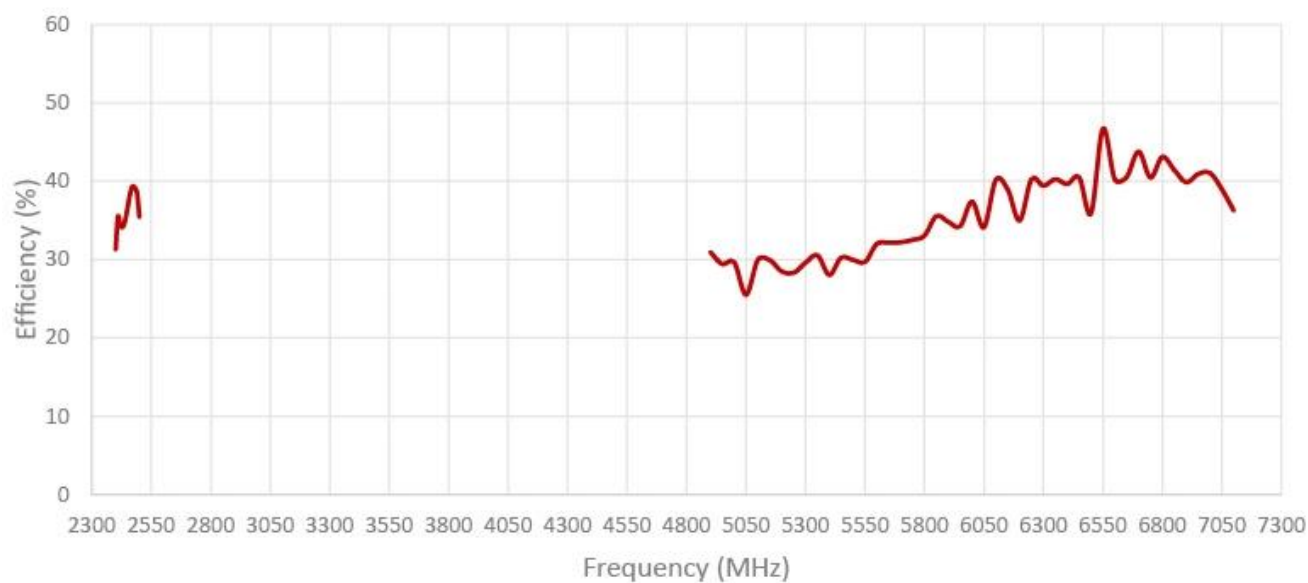

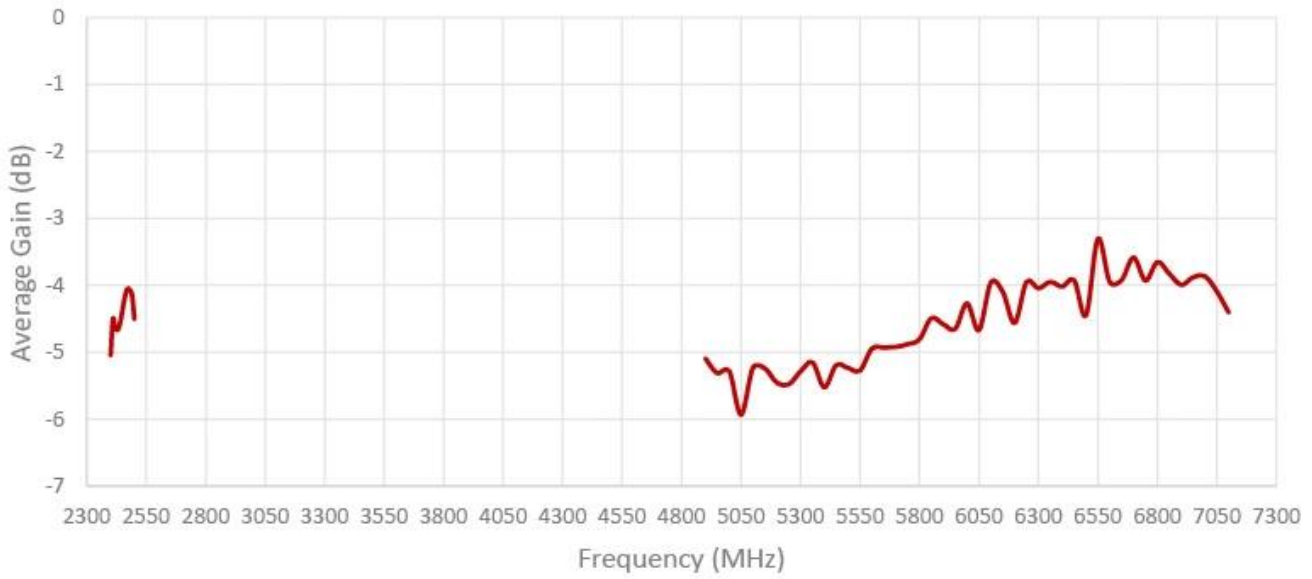

Isolation câble 5 et 6

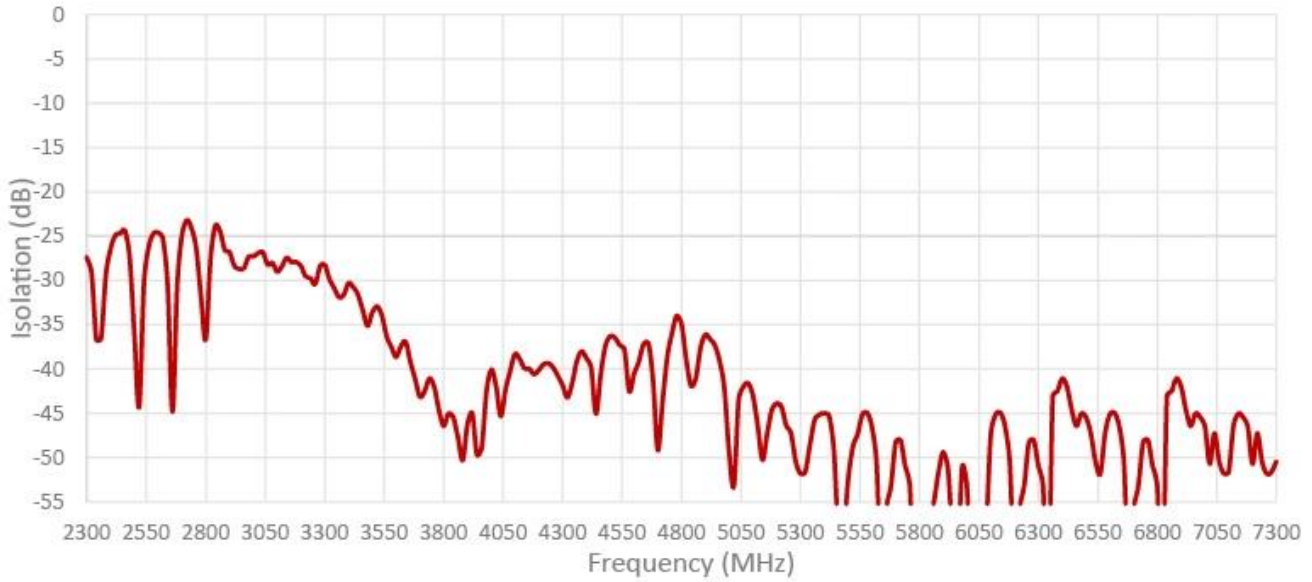



Coefficient de corrélation de l'enveloppe câble 5 et 6

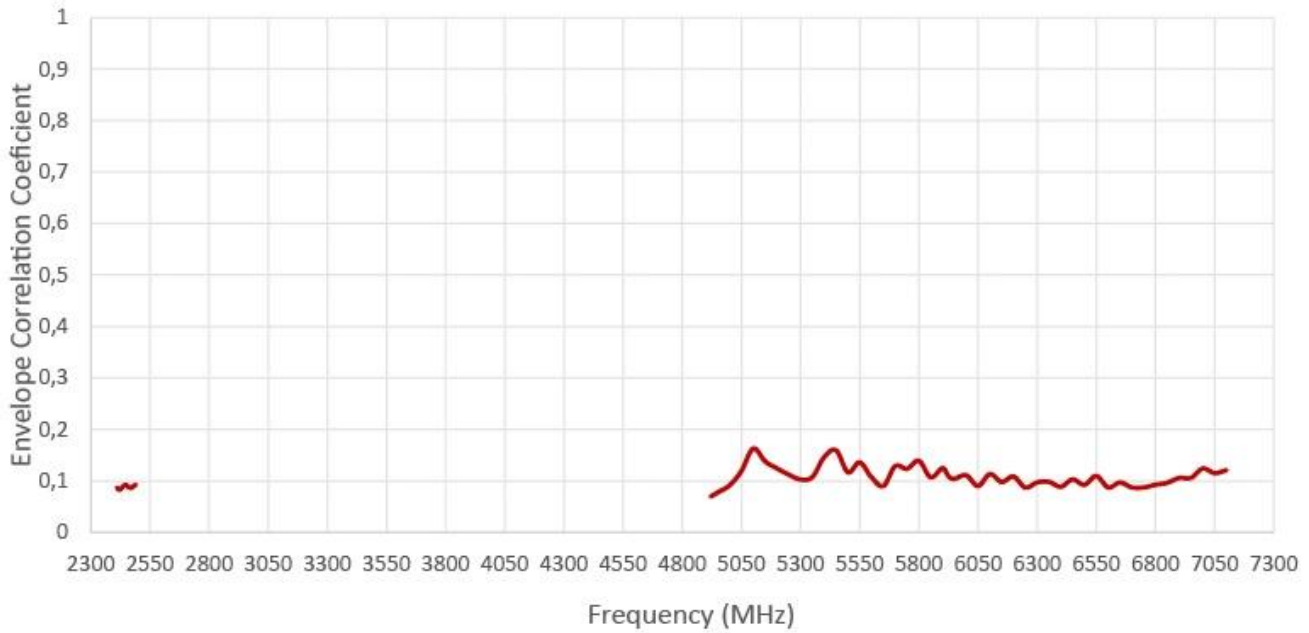

Isolation câble 5 et 7

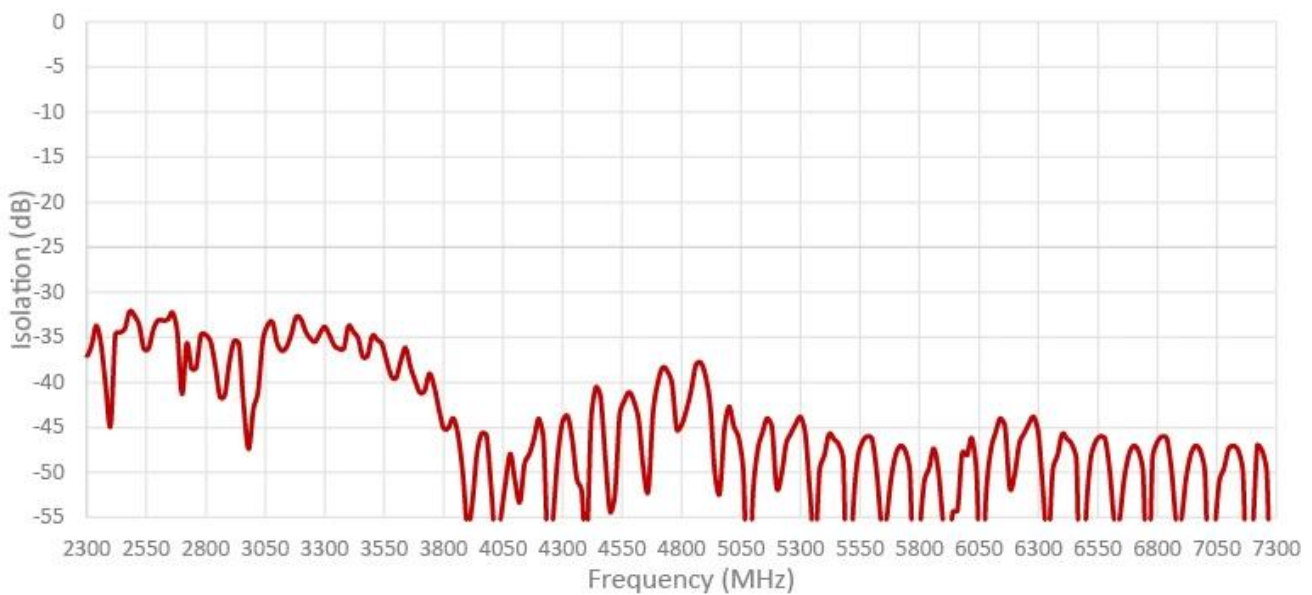



Coefficient de corrélation de l'enveloppe câble 5 et 7

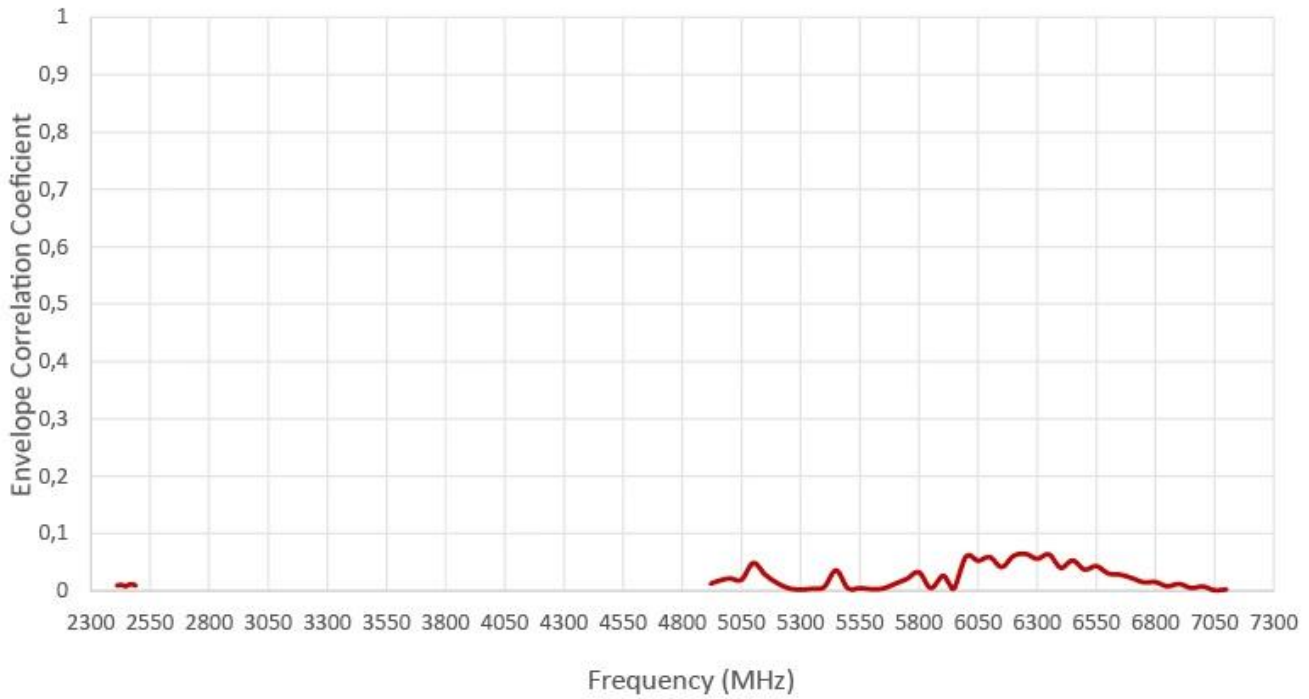

Isolation câble 5 et 8

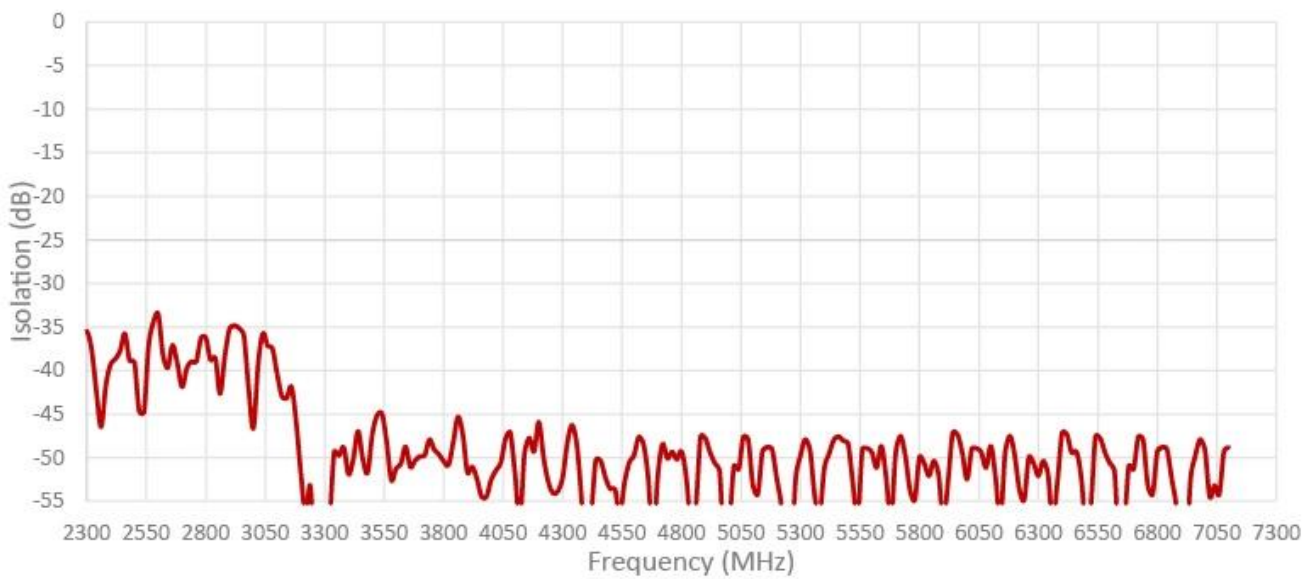



Coefficient de corrélation de l'enveloppe câble 5 et 8

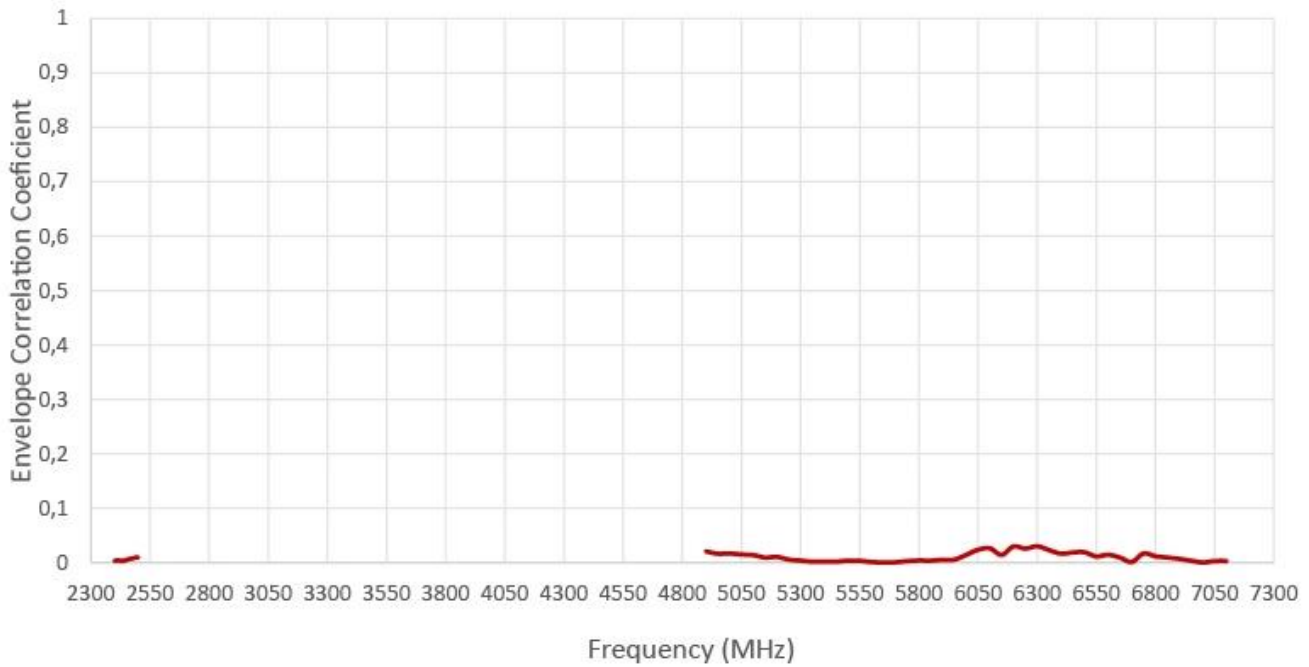

Isolation câble 6 et 7

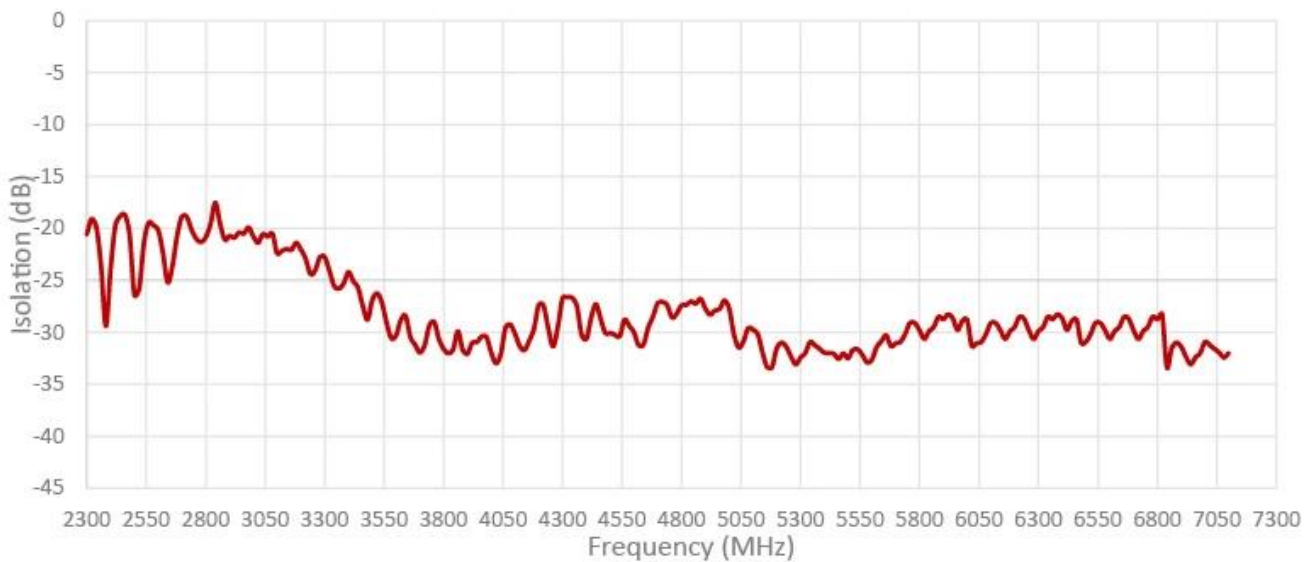



Coefficient de corrélation de l'enveloppe câble 6 et 7

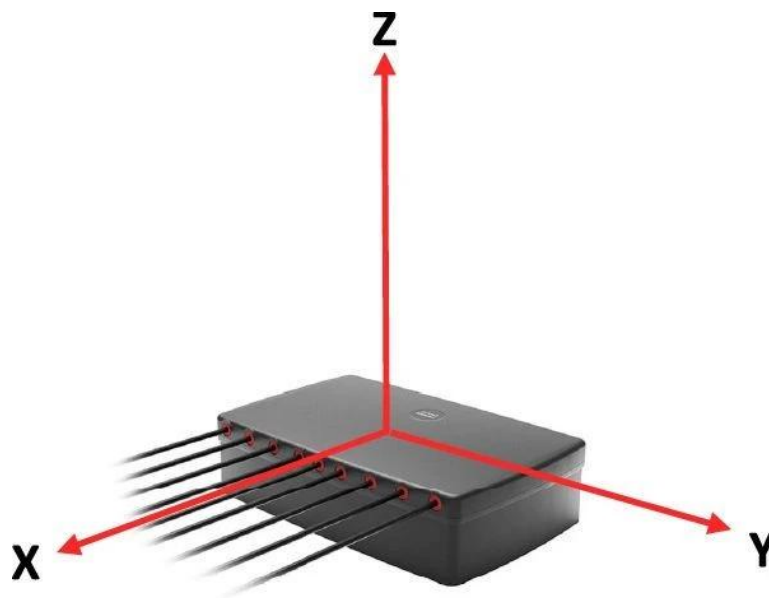
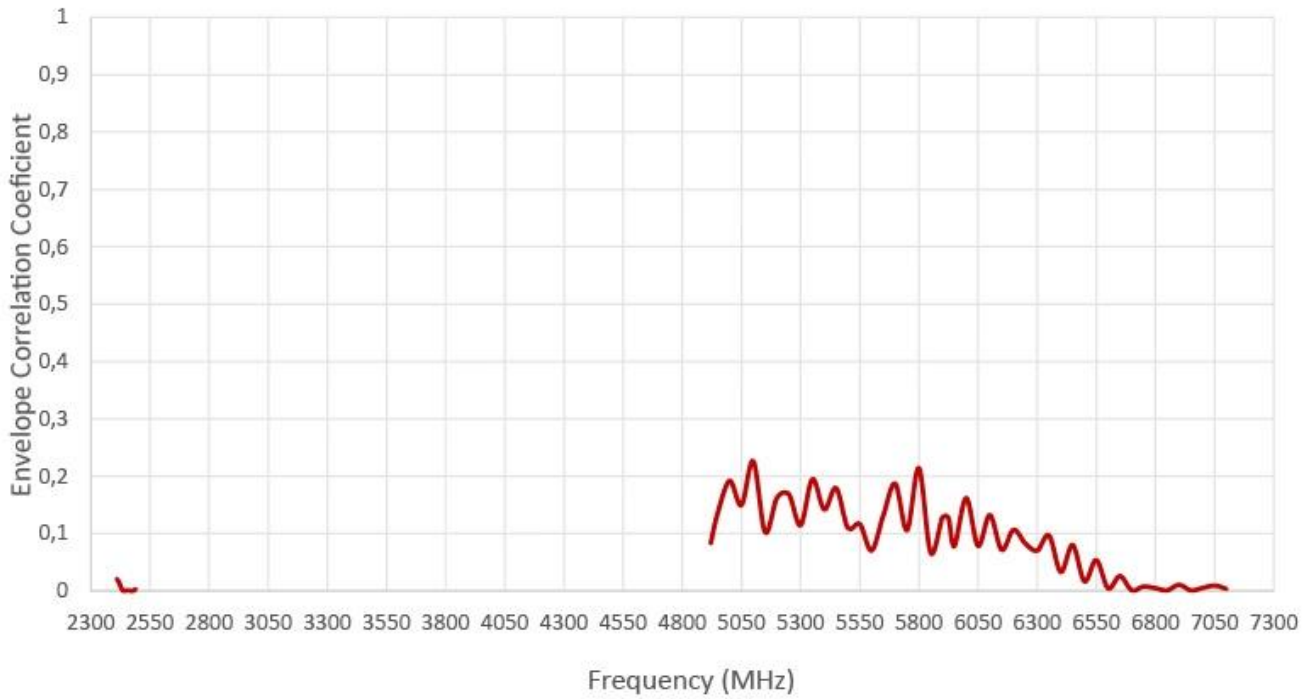

Radiation pattern reference



Câble 1 : 2G/3G/4G/5G - IoT/LPWAN

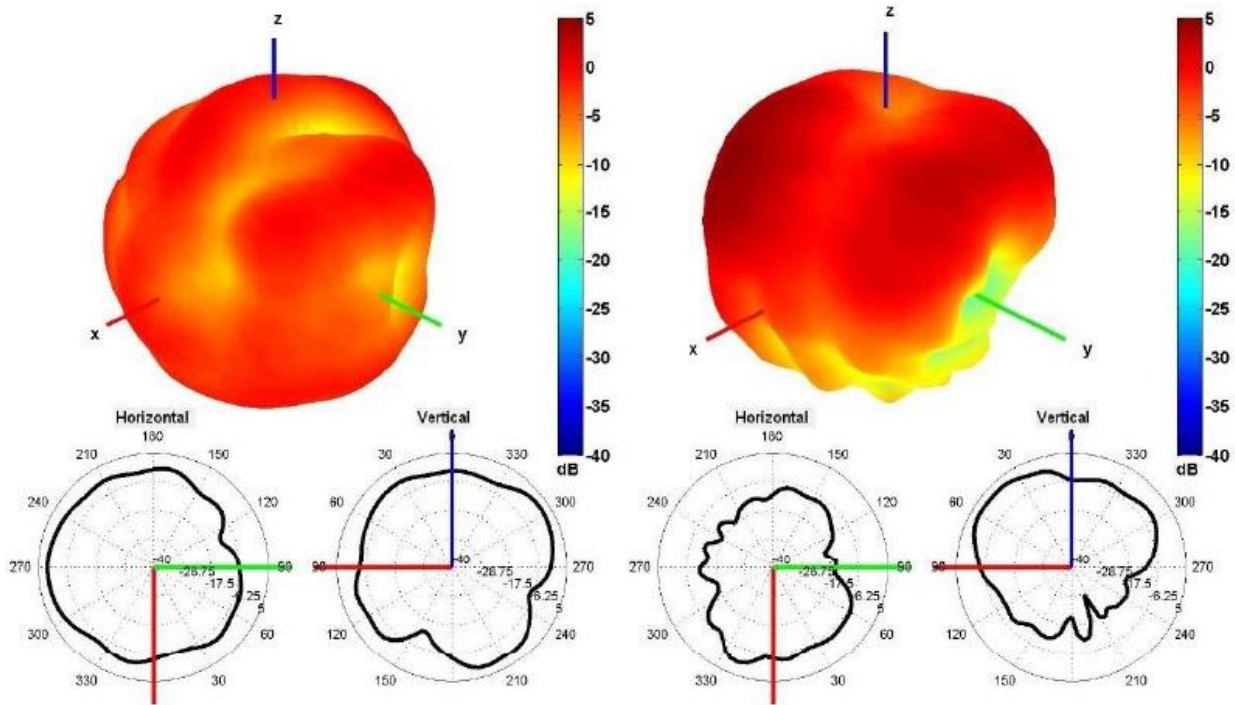

750 and 2500 MHz Radiation pattern

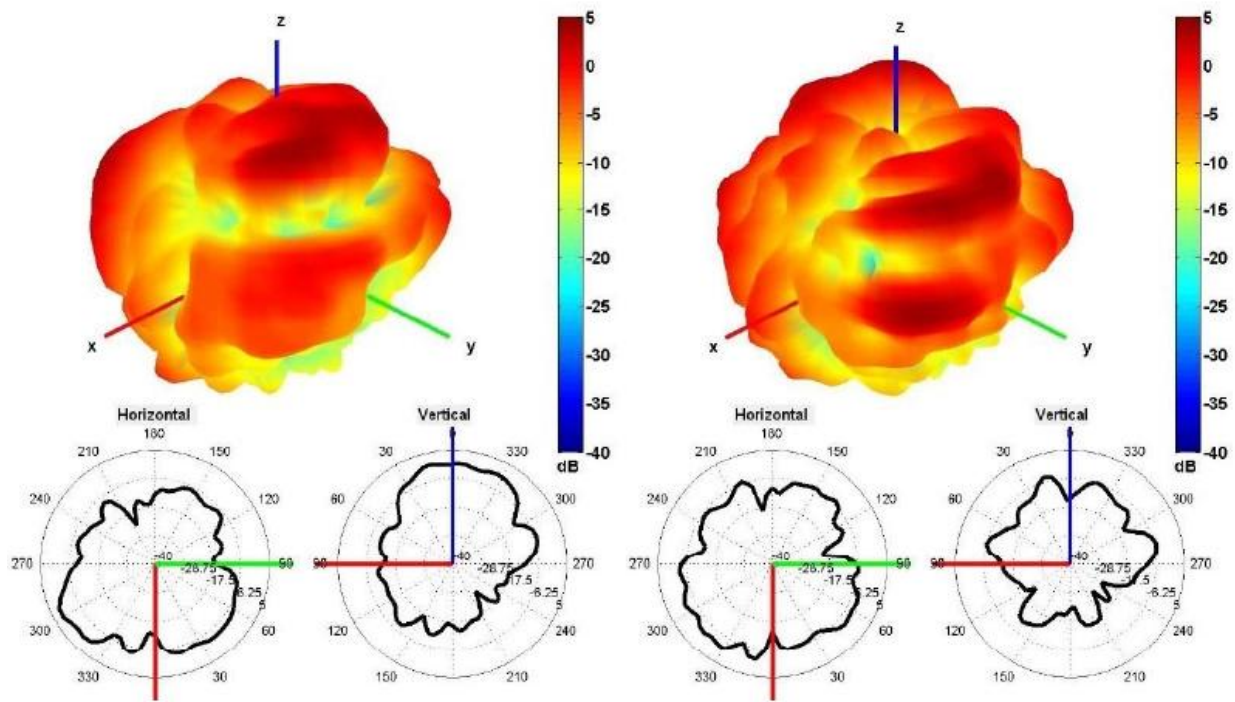

4500 and 5500 MHz Radiation pattern



Câble 2 : 2G/3G/4G/5G - IoT/LPWAN

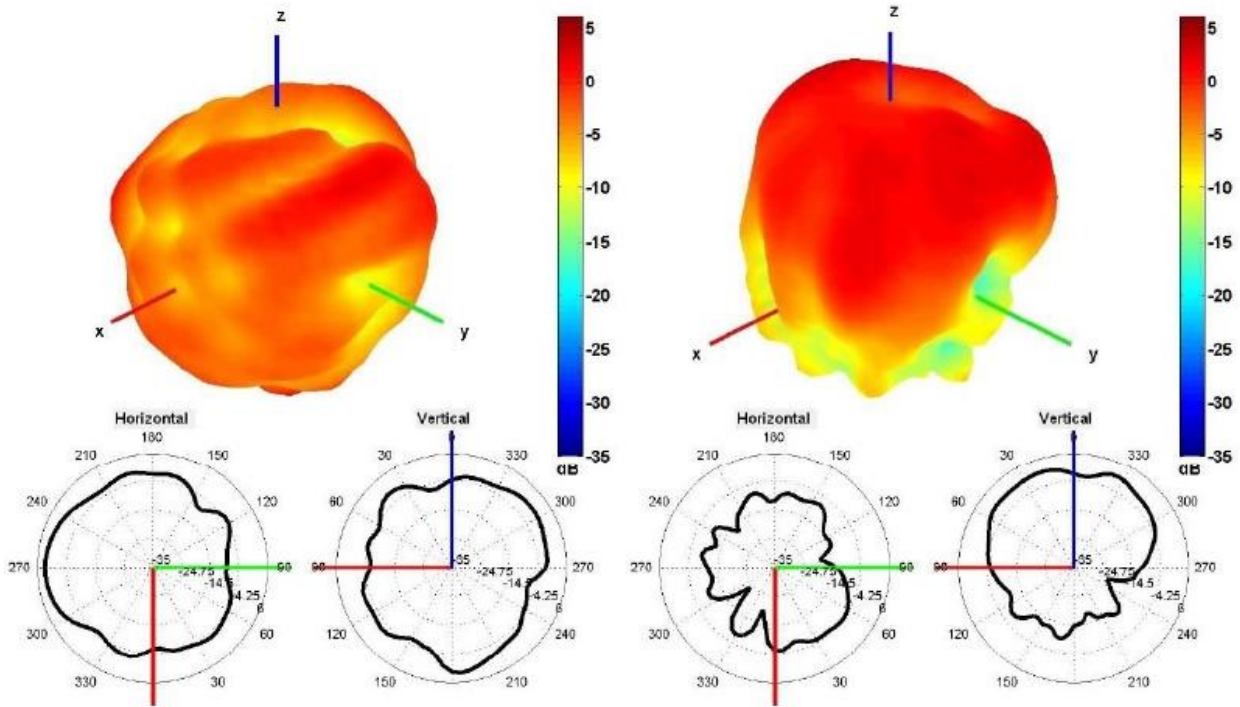

750 and 2500 MHz Radiation pattern

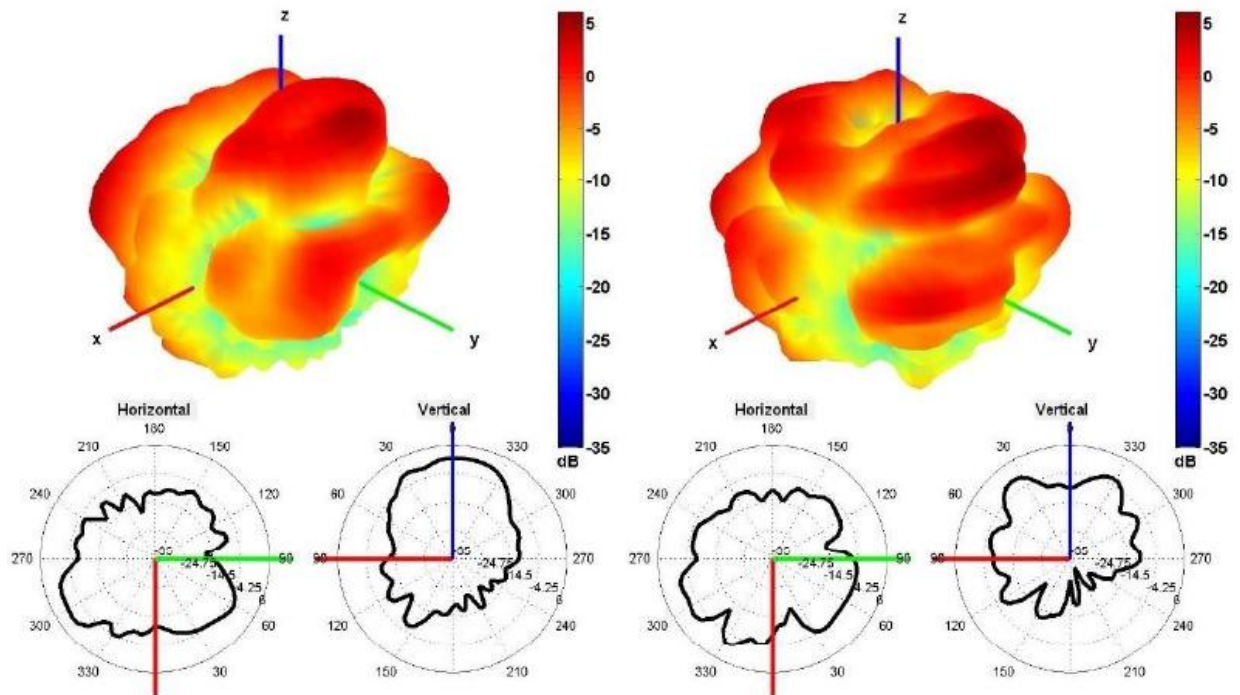

4500 and 5500 MHz Radiation pattern



Câble 3 : 2G/3G/4G/5G - IoT/LPWAN

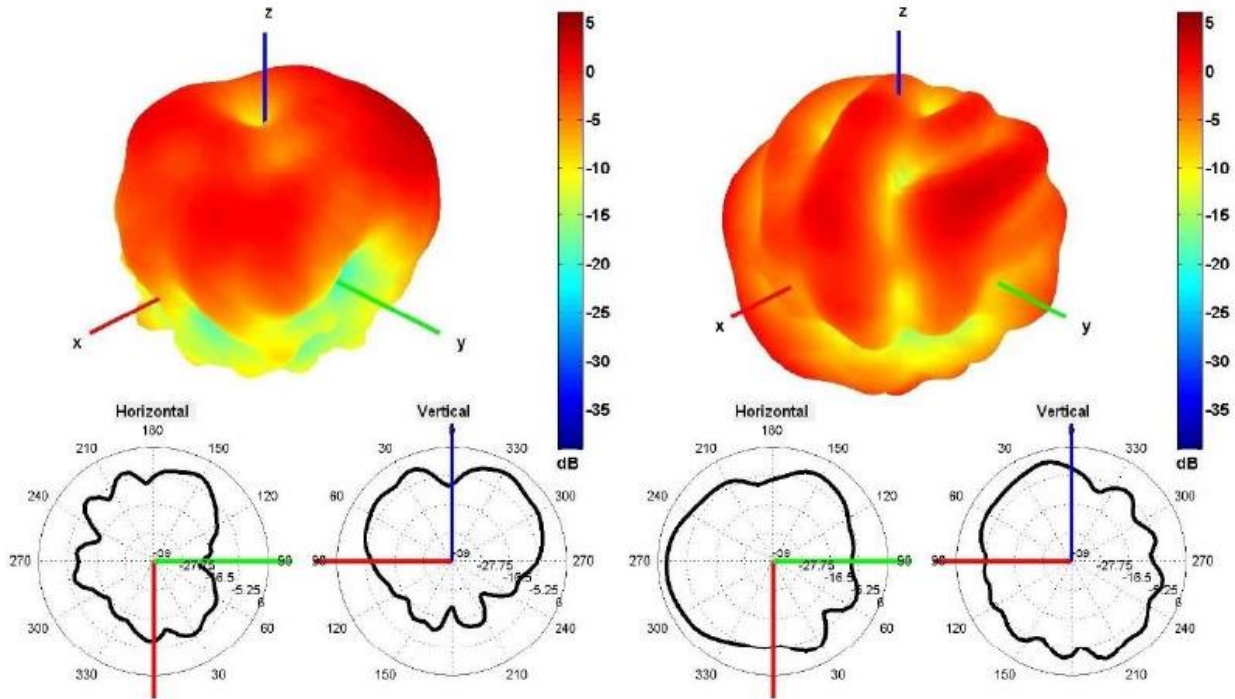

750 and 2500 MHz Radiation pattern

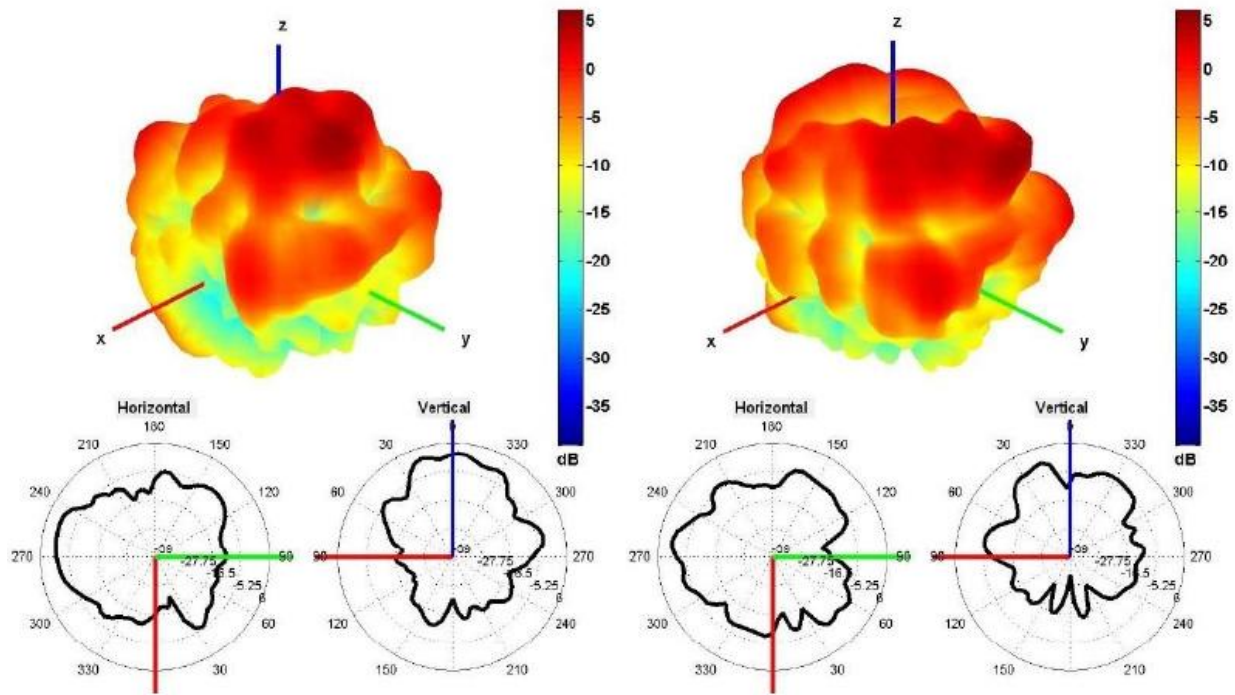

4500 and 5500 MHz Radiation pattern



Câble 4 : 2G/3G/4G/5G - IoT/LPWAN

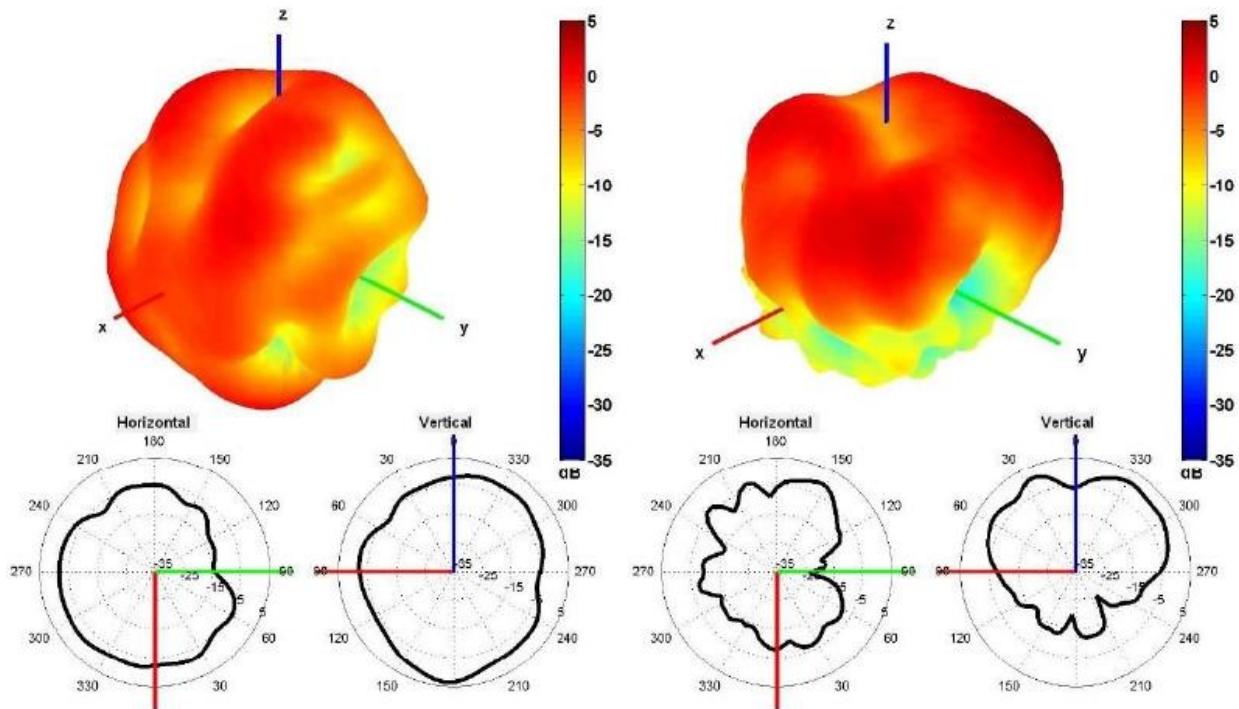

750 and 2500 MHz Radiation pattern

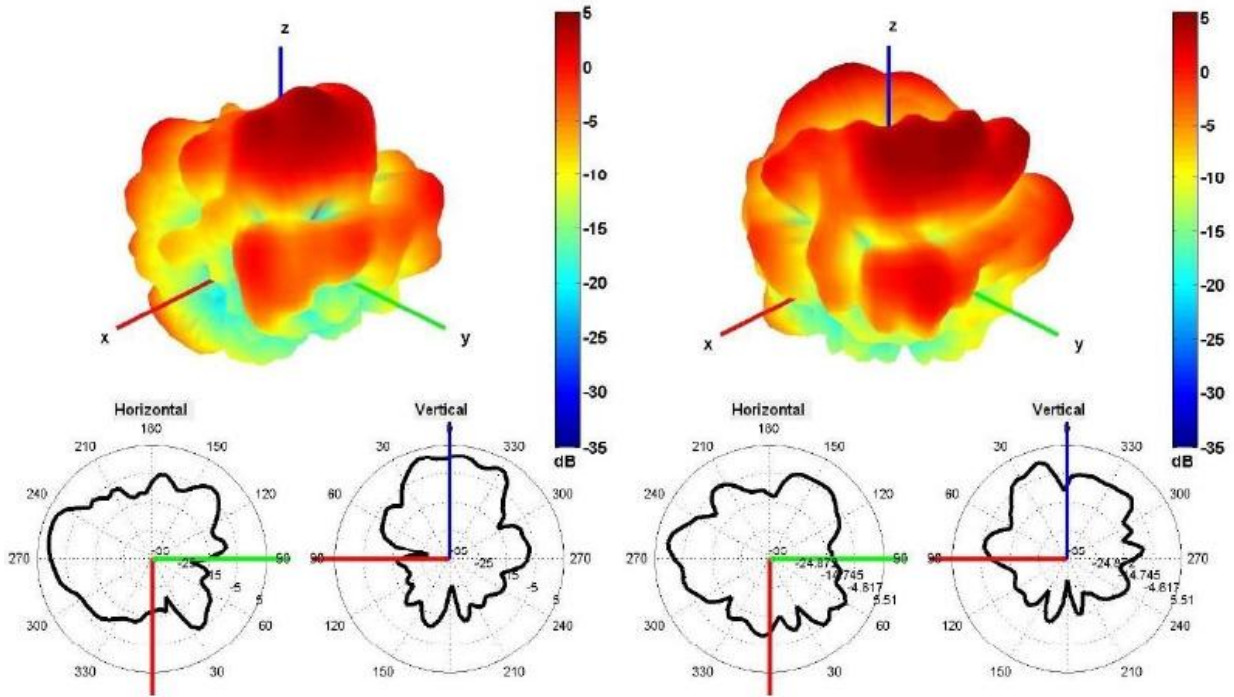

4500 and 5500 MHz Radiation pattern



Câble 5 : ISM 2,4 / 5.0 / 6.0 GHz – WiFi, Bluetooth, ZigBee

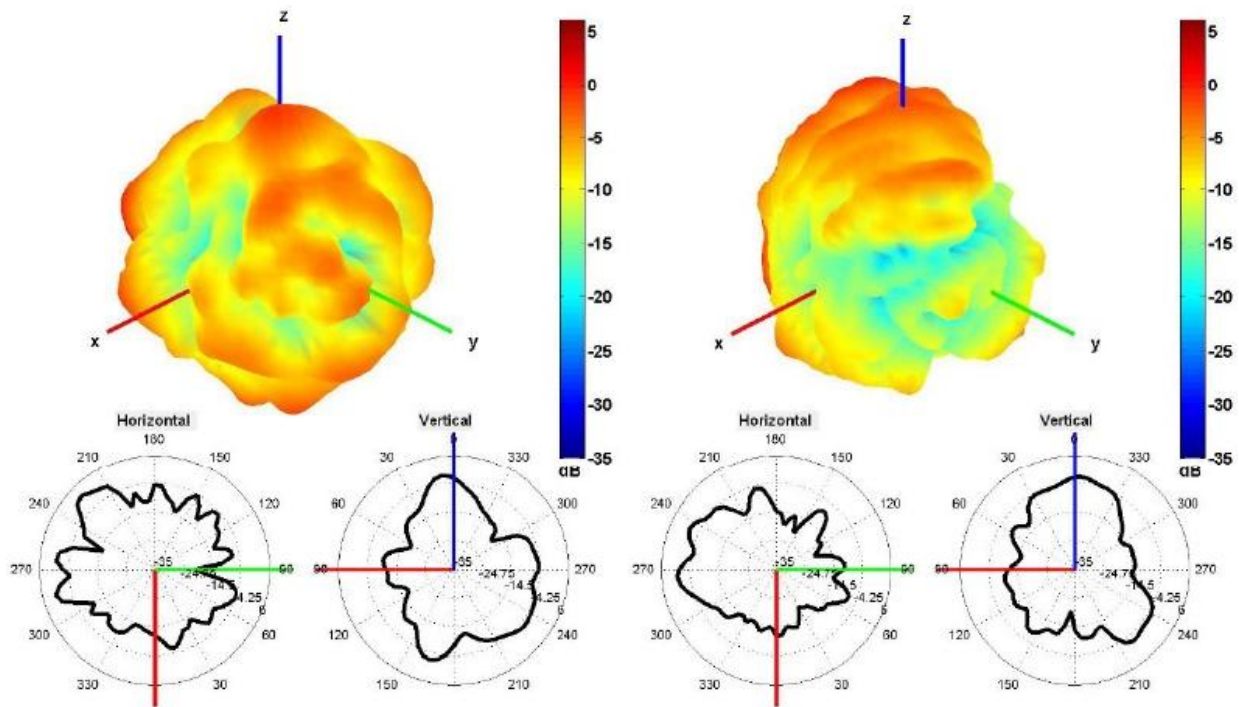

2450 and 5500 MHz Radiation pattern

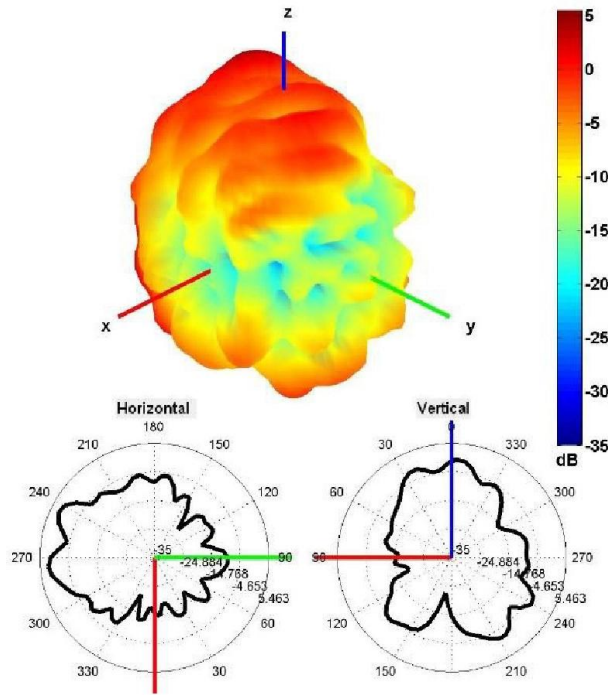

6500 MHz Radiation pattern



Câble 6 : ISM 2,4 / 5.0 / 6.0 GHz – WiFi, Bluetooth, ZigBee

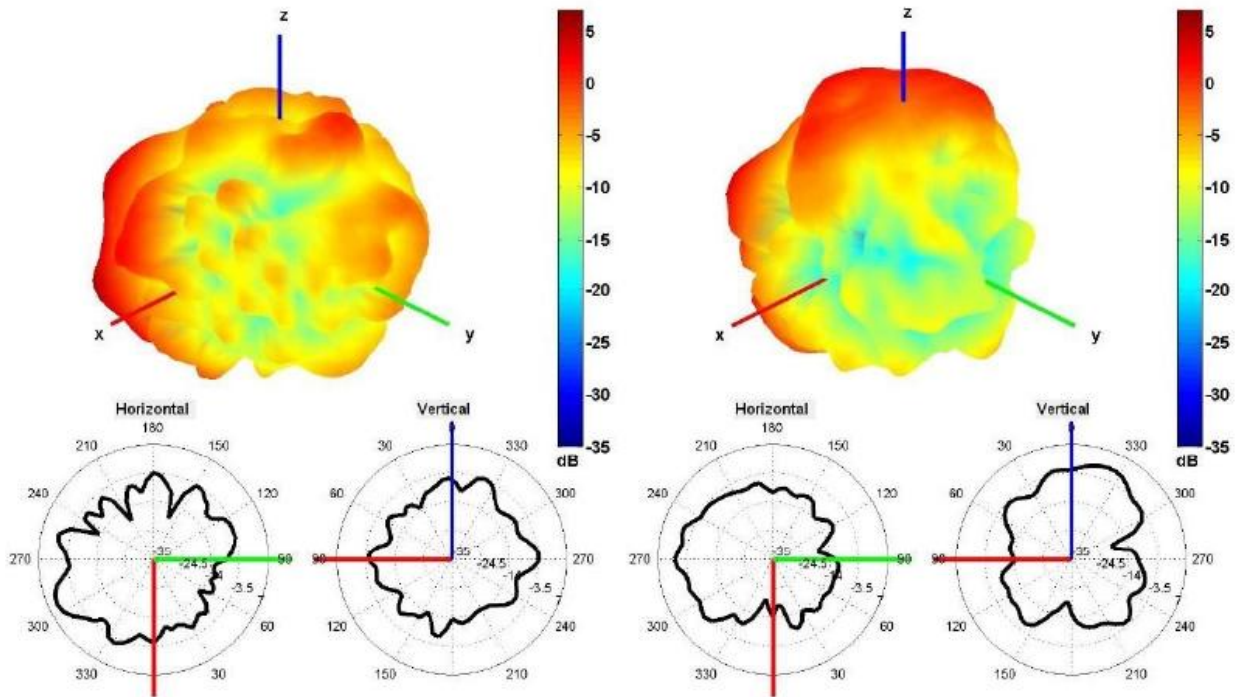

2450 and 5500 MHz Radiation pattern

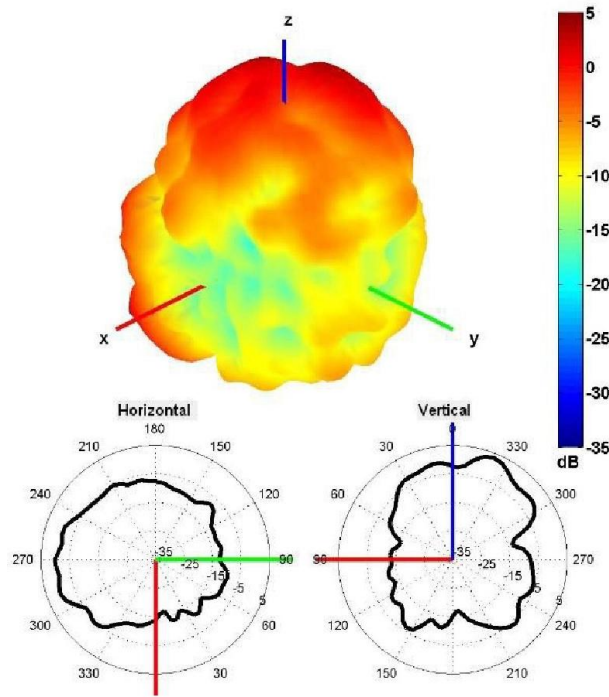

6500 MHz Radiation pattern



Câble 7 : ISM 2,4 / 5.0 / 6.0 GHz – WiFi, Bluetooth, ZigBee

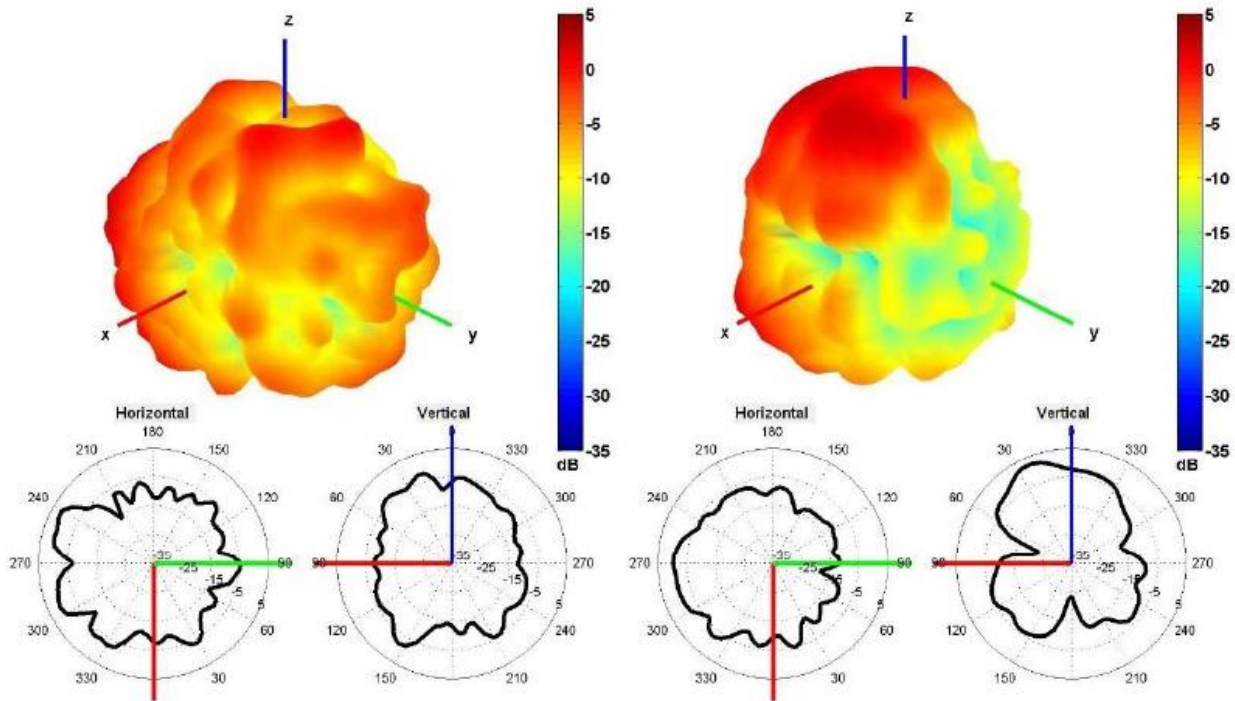

2450 and 5500 MHz Radiation pattern

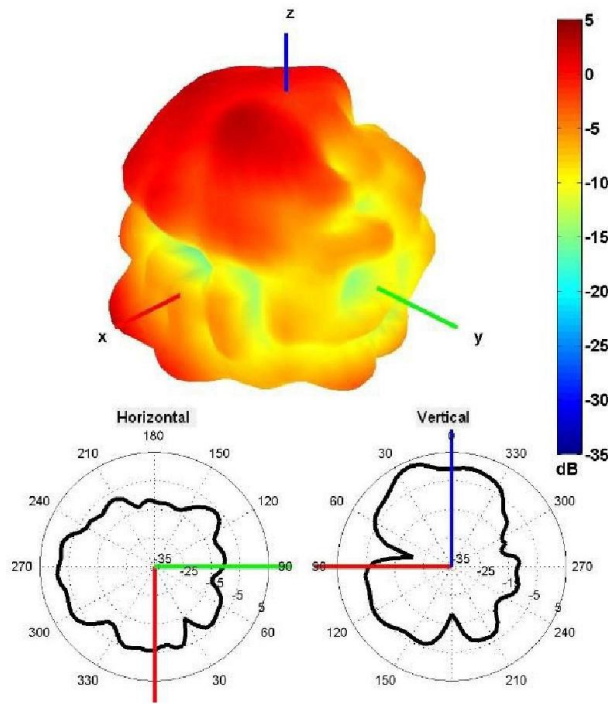

6500 MHz Radiation pattern



SCHÉMAS

